



## **SOM304RD-PI Development Kit**

**with 4S / 4 USB / LAN / 2GPIO / PWMx24**

**256MB DDR2 Onboard**

## **User's Manual**

**(Revision 1.0A)**

## ● Copyright

The information in this manual is subject to change without notice for continuous improvement of the product. All rights are reserved. The manufacturer assumes no responsibility for any inaccuracy that may be contained in this document and makes no commitment to update or to keep current information contained in this manual.

No part of this manual may be reproduced, copied, translated or transmitted, in whole or in part, in any form or by any means without the prior written permission of the ICOP Technology Inc.

©Copyright 2008 ICOP Technology Inc.

Manual No. IUMSOM304RD-PI000-01 Ver.1.0A ● September, 2012

## ● Trademarks Acknowledgment

Vortex86DX™ is the registered trademark of DMP Electronics Inc.

Other brand names or product names appearing in this document are the properties and registered trademarks of their respective owners. All names mentioned herewith are reserved for identification purpose only.

# Table of Contents

Table of Contents .....	iii
Chapter 1 Introduction.....	1
1.1 Packing List.....	1
1.2 Product Description .....	2
1.3 Specifications .....	3
1.4 Board Dimension.....	5
Chapter 2 Installation.....	8
2.1 Board Outline .....	8
2.2 Connectors & Jumpers Location .....	11
2.3 Connectors & Jumpers Summary.....	12
2.4 Pin Assignments & Jumper Settings.....	13
2.5 System Mapping.....	25
2.6 Watchdog Timer .....	30
2.7 GPIO .....	31
2.8 SPI flash.....	32
2.9 PWM .....	33
3.0 IDE to SD .....	34
Chapter 3 Driver Installation.....	35
Appendix .....	36
A. TCP/IP library for DOS real mode .....	36
B. SOM304RD-PI & SOMDX-DEV-PI Schematic .....	37
C. BIOS Default Setting.....	38
Warranty.....	39

**This page is blank**

# Chapter 1

## Introduction

### 1.1 Packing List

Product Name	Package
SOM304DX-DEV-PI	<ul style="list-style-type: none"><li>● SOM304DX-DEV-PI x 1</li><li>● HDD 40P (2.54mm) x 1</li><li>● HDD 44P (2.0mm) x 1</li><li>● RS232 cable (2.54mm) x 5</li><li>● GPIO cable (2.54mm) x 2</li><li>● USB (2.54mm) x 1</li><li>● Print cable (2.54mm) x 1</li></ul>

Product Name	Package
SOM304RD-PI	● SOM304RD-PI CPU Module x 1

Product Name	Package
PCI-VGA-Z9s	● XGI Z9s VGA/DVI PCI Display Board x 1

## 1.2 Product Description

The System on Module is a core module with the processor, memory and I/O that would contain the following benefits in the respect of system design.

- 800MHz Vortex86DX System-On-Chip
  - 256 / 512MB DDR2 system memory
  - 4 USB Ver. 2.0 (host)
  - 4 serial ports
  - 16-bit GPIO x2
  - ISA bus
  - PCI bus
  - 2 watchdog timer
  - Enhanced IDE (UltraDMA-100/66/33)
  - JTAG interface
  - PWM 24~32 channels
  - AMI BIOS
  - 4MB SPI flash
  - Single voltage +5V DC
  - Support extended operating temperature range from -20°C to +70°
- SOM304RD-PI is suitable for broad range of data-acquisition, Industrial automation, Process control, Automotive controller, AVL, Intelligent Vehicle management device, Medical device, Human machine interface, Robotics and machinery control.
- SOM304RD-PI measured at only 70mm (L)\*70mm (W)\*10.5mm (H), is designed particularly as the kernel for the diverse expandable applications. Through 8 rows of 38pin connector, SOM304RD-PI is able to provide multiple functions, such as ISA BUS, RS-232, IDE, LAN, USB and GPIO.
- To assist users easily adapt SOM304RD-PI Module into their applications, ICOP offers a complete development board and referential circuit diagram for SOM304RD-PI Module in order to reduce users' time.
- Please visit the website below for further information  
<http://www.dmp.com.tw/tech/vortex86dx/>
- As to the referential circuit drawing, please contact [info@icop.com.tw](mailto:info@icop.com.tw)

# 1.3 Specifications

## ■ SOM304RD-DEV-PI

Features	SOM304DX-DEV-PI
Bus Interface	PCI, ISA bus standard compliant
Connectors	<ul style="list-style-type: none"> <li>● 1.27mm 76-pin header for signal x4</li> <li>● 2.54mm 40-pin header for IDE x1</li> <li>● 2.54mm 26-pin header for Printer x1</li> <li>● 2.54mm 20-pin header for GPIO x2</li> <li>● 2.54mm 10-pin header for USB x1</li> <li>● 2.54mm 10-pin header for RS-232 x5</li> <li>● 2.0mm 44-pin header for IDE x1</li> <li>● 98-pin slot for ISA x1</li> <li>● 120-pin slot for PCI x2</li> <li>● 104-pin box header for PC/104 x1</li> <li>● External RJ-45 connector for Ethernet x1</li> <li>● External USB connector x2</li> <li>● External 9-pin D-Sub male connector for RS-232 x2</li> <li>● External 6-pin Mini DIN connector for Keyboard x1</li> <li>● External 6-pin Mini DIN connector for Mouse x1</li> <li>● External Audio Phone Jack x1</li> </ul>
Power Requirement	Single Voltage +5V @100mA
Dimension	170 X 170 mm (6.69 x 6.69 inches)
Weight	280g
Operating Temperature	-20°C ~ +70°C -40°C ~ +85°C (Optional)

## ■ SOM304RD-PI

Features	SOM304RD-PI
CPU	DM&P SoC CPU Vortex86DX- 800MHz Real Time Clock with Lithium Battery Backup
Cache	L1:16K I-Cache, 16K D-Cache L2 Cache 256KB
BIOS	AMI BIOS
Bus Interface	PCI, ISA bus standard compliant
System Memory	256 / 512MB DDR2 onboard
Watchdog Timer	Software programmable from 30.5 us to 512 seconds x2 sets(Watchdog 1 fully compatible with M6117D)
LAN	Integrated 10/100Mbps Ethernet
Flash Disk Support	Onboard 4MB SPI Flash Disk Onboard SST Flash Disk (512MB/1GB/2GB/4GB are optional) MSTI EmbedDisk Module (16MB and above) 44-pin IDE to Micro SD (Optional)
PWM	24~32 Channels
I2C	Controlled by GP 34/35
Serial Console	Controlled by GP 36/37
I/O Interface	<ul style="list-style-type: none"> <li>● Enhanced IDE port (UltraDMA-100/66/33) x1</li> <li>● RS-232 port x4</li> <li>● USB port (Ver2.0) x4</li> <li>● Parallel port x1</li> <li>● 16-bit GPIO port x2</li> <li>● 10/100Mbps Ethernet port x1</li> </ul>
Connectors	<ul style="list-style-type: none"> <li>● 1.27mm 76-pin box header for signal x4</li> <li>● 1.25mm 6-pin Wafer for JTAG x1</li> </ul>
Power Requirement	Single Voltage +5V @ 480mA
Dimension	70 mm (L) x 70 mm (W) x 10.5 mm (H) (With Cover)
Weight	25g
Operating Temperature	-20°C ~ +70°C -40°C ~ +85°C (Optional)



# 1.4 Board Dimension

## ■ SOM304DX-DEV-PI

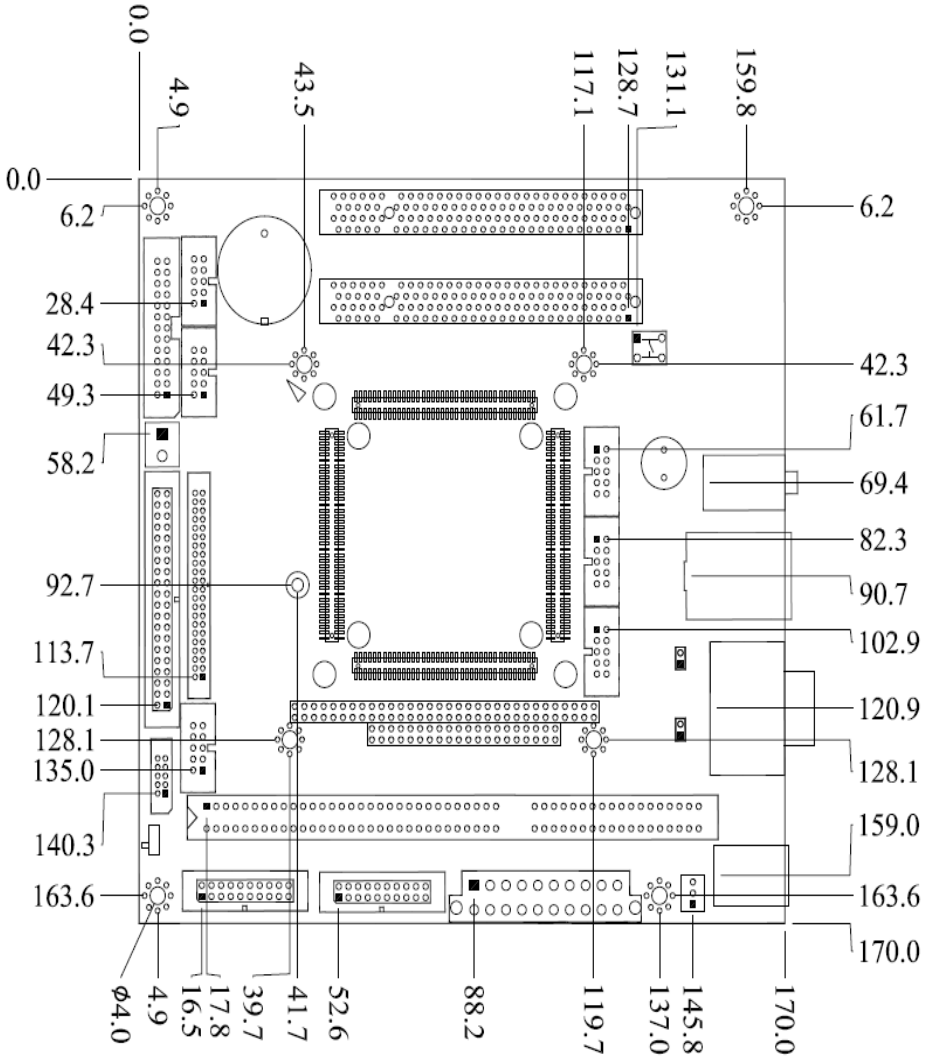

■ SOM304RD-PI

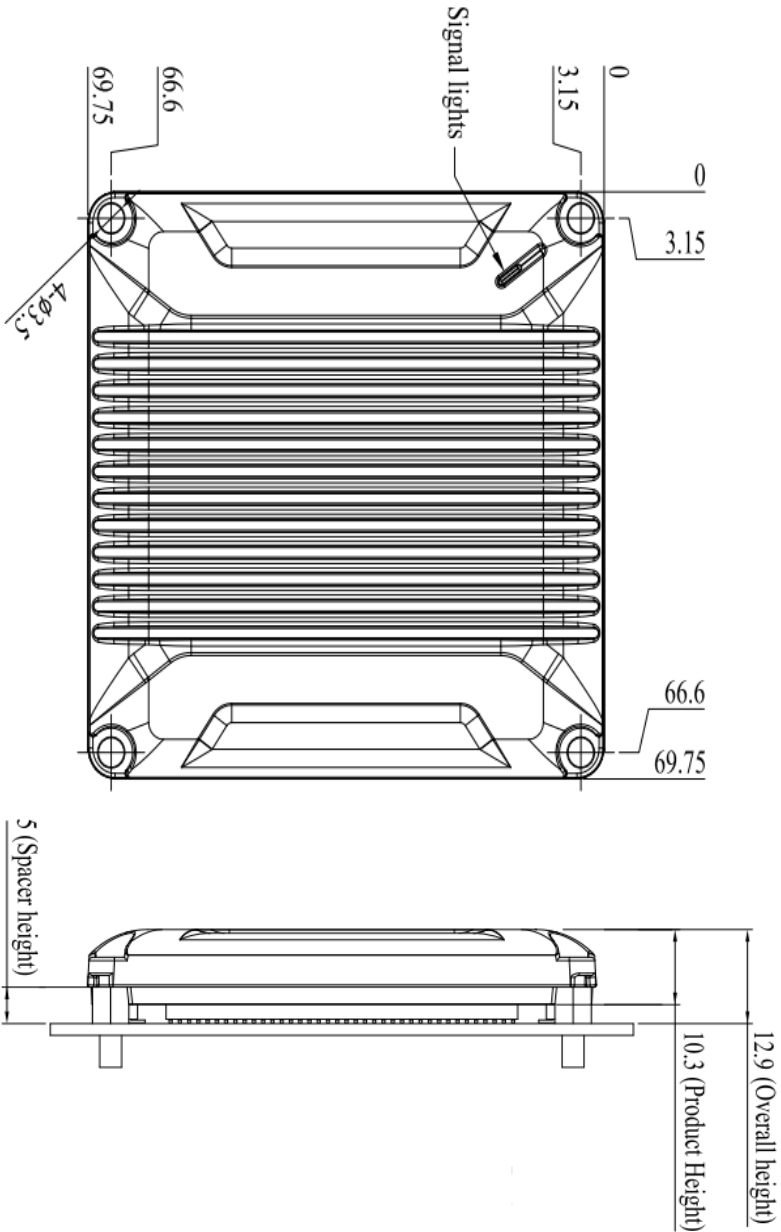



# Chapter 2

## Installation

### 2.1 Board Outline

#### ■ SOM304DX-DEV-PI

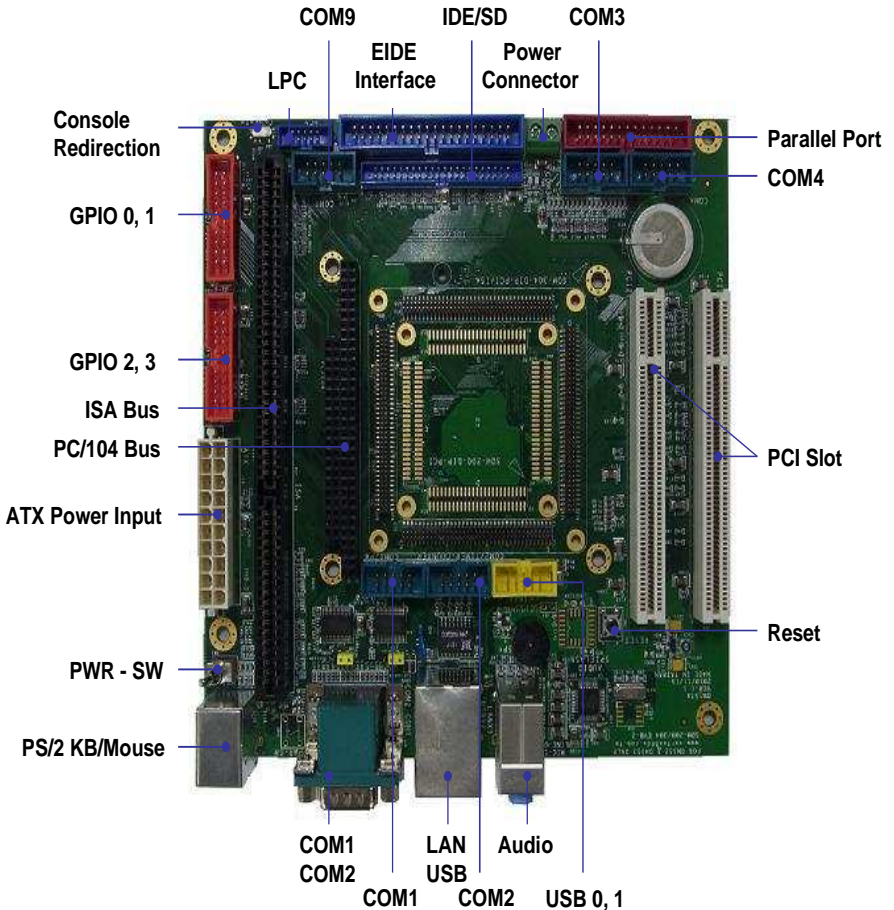

## ■ SOM304DX-DEV-PI with PCI-VGA-Z9s

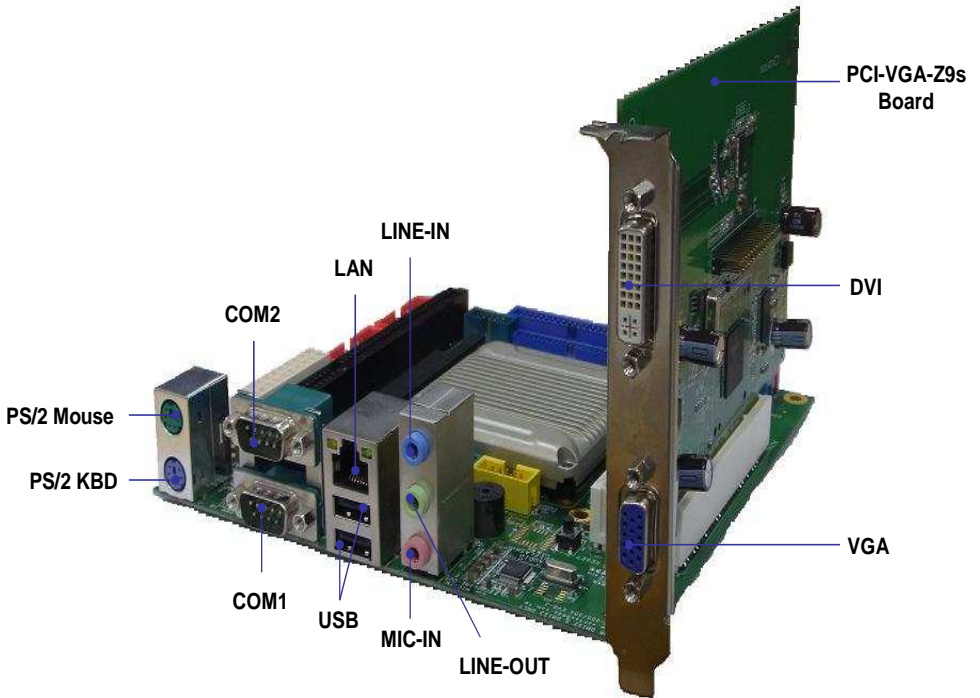

## ■ SOM304RD-PI

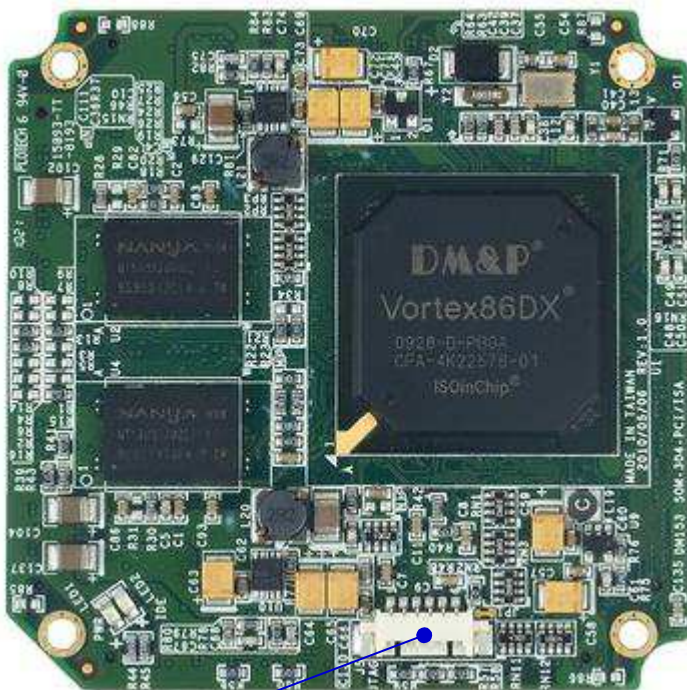

JTAG

## 2.2 Connectors & Jumpers Location

### Connectors

#### ■ SOM304DX-DEV-PI

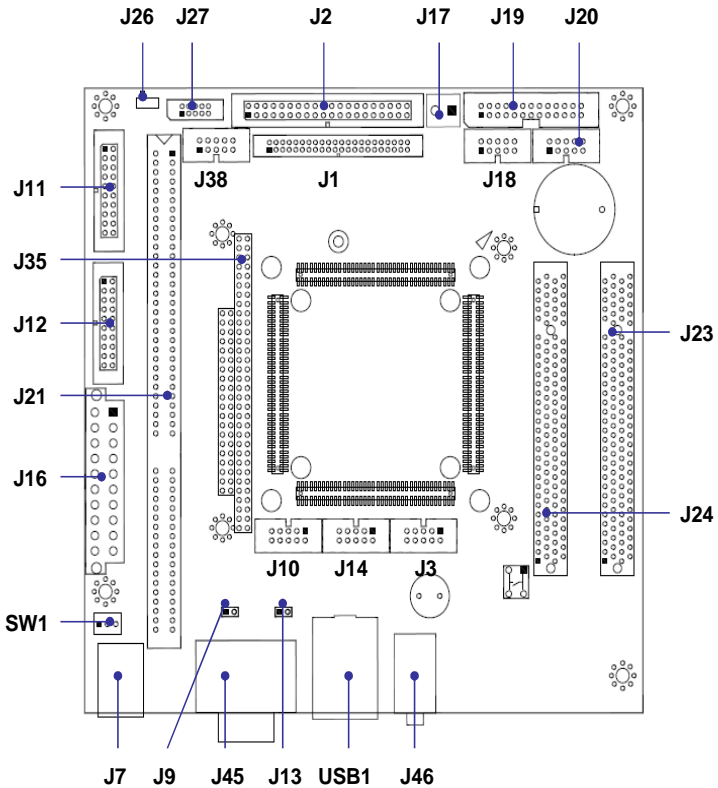

## 2.3 Connectors & Jumpers Summary

### ■ SOM304DX-DEV-PI

Nbr	Description	Type of Connections	Pin nbrs.
J1	IDE Connector	Box Header, 2.0Ø ,22x2	44-pin
J2	IDE Connector	Box Header, 2.54Ø , 20x2	40-pin
J3	USB 2/ USB 3	Box Header, 2.54Ø , 5x2	10-pin
USB1A	USB 0/ USB 1	USB connector	8-pin
USB1B	Ethernet LAN	RJ45 Connector	8-pin
J7A	PS/2 Keyboard	Mini-DIN Female	6-pin
J7B	PS/2 Mouse	Mini-DIN Female	6-pin
J9	TTL/RS232 Mode Selector	Pin Header, 2,54Ø ,1x2	2-pin
J10	COM1/P4/PWM	Box Header, 2.54Ø 5x2	10-pin
J11	GPIO ( P0 / P1 /PWM)	Box Header, 2.54Ø ,10x2	20-pin
J12	GPIO (P2/P3/ SPI/2C/PWM)	Box Header, 2.54Ø ,10x2	20-pin
J13	TTL/RS232 Mode Selector	Pin Header, 2,54Ø ,1x2	2-pin
J14	COM2	Box Header, 2.54Ø 5x2	10-pin
J16	ATX Power	ATX header	20-pin
J17	Power Connector	Terminal Block 5.0Ø,2x1	2-pin
J18	COM3 TTL Mode	Box Header, 2.54Ø 5x2	10-pin
J19	Print	Box Header, 2.54Ø , 13x2	26-pin
J20	COM4 TTL Mode	Box Header, 2.54Ø 5x2	10-pin
J21	ISA Slot	ISA Slot	98-pin
J23	PCI Slot1	PCI Slot	120-pin
J24	PCI Slot2	PCI Slot	120-pin
J26	Console Redirection		
J35A	PC104 Connector – 64 pin	Box Header, 2.54Ø 32x2	64-pin
J35B	PC104 Connector – 40 pin	Box Header, 2.54Ø 20x2	40-pin
J37	LPC	Box Header, 2.0Ø ,5x2	10-pin
J38	COM9	Box Header, 2.54Ø ,5x2	10-pin
J45A	COM1	D-Sub Male	9-pin
J45B	COM2	D-Sub Male	9-pin
J46A	Audio Mic-In	1.25mm Phone Jack	
J46B	Audio Line-Out	1.25mm Phone Jack	
J46C	Audio Line-In	1.25mm Phone Jack	
SP1	BUZZER		



SW1	PWR-SW		
SW2	Reset		

## 2.4 Pin Assignments & Jumper Settings

### ■ SOM304DX-DEV-PI

#### J1: IDE (44 Pins)

Pin #	Signal Name	Pin #	Signal Name
1	IDERST	2	GND
3	IDED7	4	IDED8
5	IDED6	6	IDED9
7	IDED5	8	IDED10
9	IDED4	10	IDED11
11	IDED3	12	IDED12
13	IDED2	14	IDED13
15	IDED1	16	IDED14
17	IDED0	18	IDED15
19	GND	20	NC
21	IDEREQ	22	GND
23	IDEIOW	24	GND
25	IDEIOR	26	GND
27	ICHRDY	28	GND
29	IDEACK	30	GND
31	IDEINT	32	NC
33	IDESA1	34	IDECBLID
35	IDESA0	36	IDESA2
37	IDECS-0	38	IDECS1
39	IDELED	40	GND
41	VCC	42	VCC
43	GND	44	NC

## J2: IDE (40 Pins)

Pin #	Signal Name	Pin #	Signal Name
1	IDERST	2	GND
3	IDED7	4	IDED8
5	IDED6	6	IDED9
7	IDED5	8	IDED10
9	IDED4	10	IDED11
11	IDED3	12	IDED12
13	IDED2	14	IDED13
15	IDED1	16	IDED14
17	IDED0	18	IDED15
19	GND	20	VCC
21	IDEREQ	22	GND
23	IDEIOW	24	GND
25	IDEIOR	26	GND
27	ICHRDY	28	GND
29	IDEACK	30	GND
31	IDEINT	32	NC
33	IDESA1	34	IDECBLID
35	IDESA0	36	IDESA2
37	IDECS0	38	IDECS1
39	IDELED	40	GND

## J3: USB

Pin #	Signal Name	Pin #	Signal Name
1	VCC	2	VCC
3	LUSBD0-	4	LUSBD1-
5	LUSBD0+	6	LUSBD1+
7	GND	8	GND
9	GGND	10	GGND

### Note:

USB port 0, 1 will be occupied if audio function is available.

## USB1A: USB0/1

Pin #	Signal Name	Pin #	Signal Name
1	VCC	2	VCC
3	-DATA	4	-DATA
5	+DATA	6	+DATA
7	GND	8	GND

## USB1B: Ethernet LAN

Pin #	Signal Name	Pin #	Signal Name
1	TD+	2	TD-
3	RO+	4	NC
5	NC	6	RO-
7	NC	8	NC

## J7A: PS/2 Keyboard

Pin #	Signal Name	Pin #	Signal Name
1	KBDATA	2	NC
3	GND	4	VCC
5	KBCLK	6	RO-

## J7B: PS/2 Mouse

Pin #	Signal Name	Pin #	Signal Name
1	TD+	2	TD-
3	RO+	4	NC
5	NC	6	RO-

## J9: TTL/RS232 Mode Selector (Open: On, Close: Off)

Pin #	Signal Name	Pin #	Signal Name
1	GND	2	VCC

## J10: COM1/P4/PWM

Pin #	Signal Name	Pin #	Signal Name
1	DCD1	2	RXD1
3	TXD1	4	DTR1
5	GND	6	DSR1
7	RTS1	8	CTS1
9	RI1	10	TXDEN1/VCC

## J11: GPIO (P0/ P1/ PWM)

Pin #	Signal Name	Pin #	Signal Name
1	GND	2	VCC
3	GP00	4	GP10
5	GP01	6	GP11
7	GP02	8	GP12
9	GP03	10	GP13
11	GP04	12	GP14
13	GP05	14	GP15
15	GP06	16	GP16
17	GP07	18	GP17
19	VCC	20	GND

## J12: GPIO (P2/ P3/ SPI/ I2C/PWM)

Pin #	Signal Name	Pin #	Signal Name
1	GND	2	VCC
3	GP20	4	SPICS
5	GP21	6	SPICLK
7	GP22	8	SPIDO
9	GP23	10	SPIDI
11	GP24	12	GP34
13	GP25	14	GP35
15	GP26	16	GP36
17	GP27	18	GP37
19	VCC	20	GND

### Note:

If you Enable 4M SPI flash Disk on the BIOS setting, you cannot use GP30~GP37 Pins.

## J13: TTL/RS232 Mode Selector (Open: On, Close: Off)

Pin #	Signal Name	Pin #	Signal Name
1	GND	2	VCC

## J14: COM2/Timer Counter

Pin #	Signal Name	Pin #	Signal Name
1	DCD2	2	RXD2
3	TXD2	4	DTR2
5	GND	6	DSR2
7	RTS2	8	CTS2
9	RI2	10	TXDEN2/VCC

## J16: ATX Power

Pin #	Signal Name	Pin #	Signal Name
1	3V3	2	3V3
3	GND	4	VCC
5	GND	6	VCC
7	GND	8	NC
9	SB5V	10	+12V
11	3V3	12	-12V
13	GND	14	SB5V
15	GND	16	GND
17	GND	18	-5V
19	VCC	20	VCC

## J17: Power Connector (Terminal Block 5.0mm)

Pin #	Signal Name
1	+5V
2	GND

## J18: COM3 TTL Mode

Pin #	Signal Name	Pin #	Signal Name
1	DCD3	2	RXD3
3	TXD3	4	DTR3
5	GND	6	DSR3
7	RTS3	8	CTS3
9	RI3	10	VCC

## J19: PRINT

Pin #	Signal Name	Pin #	Signal Name
1	STB-	14	AFD-
2	PD0	15	ERR-
3	PD1	16	INIT-
4	PD2	17	SLIN-
5	PD3	18	GND
6	PD4	19	GND
7	PD5	20	GND
8	PD6	21	GND
9	PD7	22	GND
10	ACK-	23	GND
11	BUSY	24	GND
12	PE	25	GND
13	SLCT	26	NC

## J20: COM 4 TTL Mode

Pin #	Signal Name	Pin #	Signal Name
1	DCD4	2	RXD4
3	TXD4	4	DTR4
5	GND	6	DSR4
7	RTS4	8	CTS4
9	RI4	10	VCC

## J35A: PC104 Connector – 64pin

Pin #	Signal Name	Pin #	Signal Name
1	IOCHCHK *	2	GND
3	SD7	4	RSTDRV
5	SD6	6	VCC
7	SD5	8	IRQ9
9	SD4	10	-5V
11	SD3	12	DRQ2
13	SD2	14	-12V
15	SD1	16	OWS
17	SD0	18	+12V
19	IOCHRDY	20	GND
21	AEN	22	SMEMW *
23	SA19	24	SMEMR *
25	SA18	26	IOW *
27	SA17	28	IOR *
29	SA16	30	DACK3 *
31	SA15	32	DRQ3
33	SA14	34	DACK1 *
35	SA13	36	DRQ1
37	SA12	38	REFRESH *
39	SA11	40	SYSCLK
41	SA10	42	IRQ7
43	SA9	44	IRQ6
45	SA8	46	IRQ5
47	SA7	48	IRQ4
49	SA6	50	IRQ3
51	SA5	52	DACK2 *
53	SA4	54	TC
55	SA3	56	BALE
57	SA2	58	VCC
59	SA1	60	OSC
61	SA0	62	GND
63	GND	64	GND

## J35B: PC104 Connector – 40pin

Pin #	Signal Name	Pin #	Signal Name
1	GND	2	GND
3	MEMCS16 *	4	SBHE *
5	IOCS16 *	6	SA23
7	IRQ10	8	SA22
9	IRQ11	10	SA21
11	IRQ12	12	SA20
13	IRQ15	14	SA19
15	IRQ14	16	SA18
17	DACK0 *	18	SA17
19	DRQ0	20	MEMR *
21	DACK5 *	22	MEMW *
23	DRQ5	24	SD8
25	DACK6 *	26	SD9
27	DRQ6	28	SD10
29	DACK7 *	30	SD11
31	DRQ7	32	SD12
33	VCC	34	SD13
35	MASTER *	36	SD14
37	GND	38	SD15
39	GND	40	NC

## J37: LPC

Pin #	Signal Name	Pin #	Signal Name
1	24MHZ	2	LAD0
3	LFRAME-	4	LAD1
5	GND	6	LAD2
7	LDRQ-	8	LAD3
9	SERIRQ	10	VCC



### J38: COM9

Pin #	Signal Name	Pin #	Signal Name
1	NC	2	RXD9
3	TXD9	4	NC
5	GND	6	NC
7	NC	8	NC
9	NC	10	VCC

Only support SOM200SX-PC

### J45A: COM 1

Pin #	Signal Name	Pin #	Signal Name
1	DCD1	2	RXD1
3	TXD1	4	DTR1
5	GND	6	DSR1
7	RTS1	8	CTS1
9	RI1		

### J45B: COM 2

Pin #	Signal Name	Pin #	Signal Name
1	DCD2	2	RXD2
3	TXD2	4	DTR2
5	GND	6	DSR2
7	RTS2	8	CTS2
9	RI2		

■ SOM304RD-PI

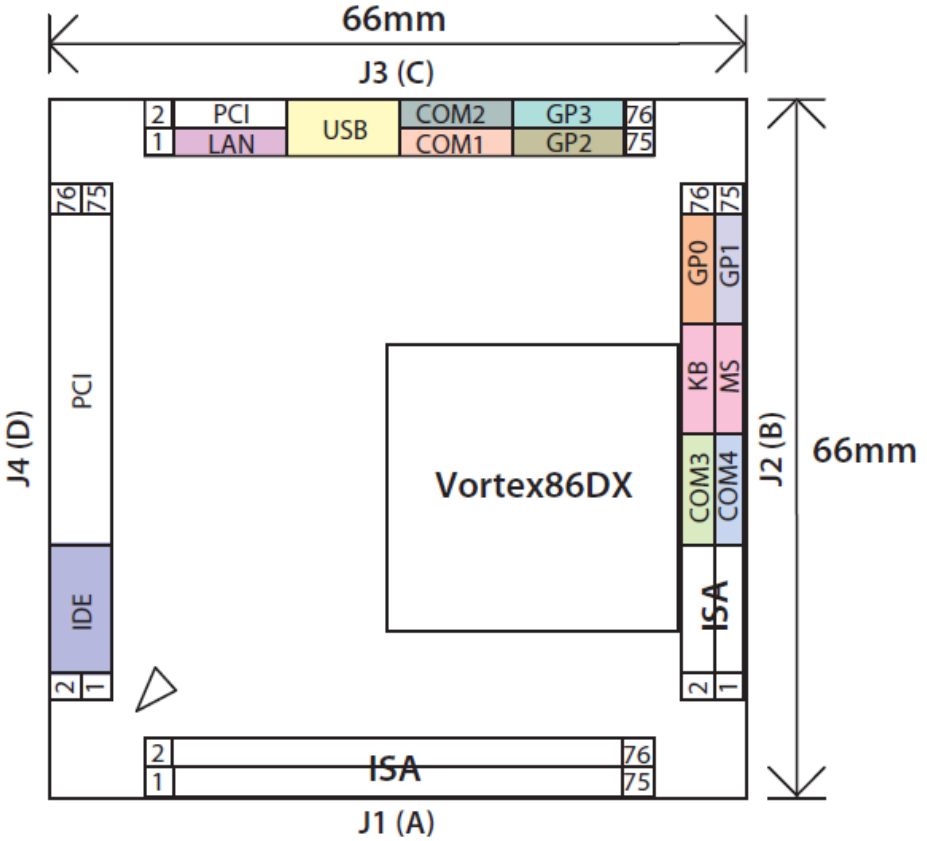

## ■ SOM304RD-PI

### J1/J2/J3/J4: SOM304RD-PI Signal Assignment

J1(A)				J2(B)			
Pin	Signal Name	Pin	Signal Name	Pin	Signal Name	Pin	Signal Name
1	GND	2	IOCHCK	1	DRQ6	2	LA17
3	RSTDRV	4	SD7	3	DACK7	4	MEMR
5	IRQ9	6	SD6	5	DRQ7	6	MEMW
7	DRQ2	8	SD5	7	SD8	8	SD9
9	OVS	10	SD4	9	SD10	10	SD11
11	SMEMW	12	SD3	11	SD12	12	SD13
13	SMEMR	14	SD2	13	SD14	14	SD15
15	IOW	16	SD1	15	GPCS0	16	GPCS1
17	IOR	18	SD0	17	GND	18	GND
19	DACK3	20	IOCHRDY	19	CTS3\	20	DSR3\
21	DRQ3	22	AEN	21	DTR3\	22	RXD3\
23	DACK1	24	SA19	23	RI3\	24	RTS3\
25	DRQ1	26	SA18	25	TXD3\	26	DCD3\
27	REFRESH	28	SA17	27	CTS4\	28	DSR4\
29	GND	30	SA16	29	DTR4\	30	RXD4\
31	SYSCLK	32	SA15	31	RI4\	32	RTS4\
33	IRQ7	34	SA14	33	TXD4\	34	DCD4\
35	IRQ6	36	SA13	35	PPD0	36	PSTB-
37	IRQ5	38	SA12	37	PPD1	38	PAFD-
39	IRQ4	40	SA11	39	PPD2	40	PERROR-
41	IRQ3	42	SA10	41	PPD3	42	PINIT-
43	DACK2	44	SA9	43	PPD4	44	PSLIN-
45	TC	46	SA8	45	PPD5	46	PACK-
47	BALE	48	SA7	47	PPD6	48	PBUSY
49	OSC	50	SA6	49	PPD7	50	PPE
51	MEMCS16	52	SA5	51	GND	52	PSLCT
53	IOCS16	54	SA4	53	RESET	54	GND
55	IRQ10	56	SA3	55	MSCLK	56	KBCLK
57	IRQ11	58	SA2	57	MSDATA	58	KBDATA
59	IRQ12	60	SA1	59	VBATT	60	SPEAKER
61	GND	62	SA0	61	GP00	62	GP01
63	IRQ15	64	SBHE	63	GP02	64	GP03
65	IRQ14	66	LA23	65	GP04	66	GP05
67	DACK0	68	LA22	67	GP06	68	GP07
69	DRQ0	70	LA21	69	GP10	70	GP11
71	DACK5	72	LA20	71	GP12	72	GP13
73	DRQ5	74	LA19	73	GP14	74	GP15
75	DACK6	76	LA18	75	GP16	76	GP17

J3(C)				J4(D)			
Pin	Signal Name	Pin	Signal Name	Pin	Signal Name	Pin	Signal Name
1	PGNT-1	2	AD31	1	IDERST	2	IDED8
3	PGNT-0	4	PREQ-2	3	IDED7	4	IDED9
5	PCICLK3	6	PREQ-1	5	IDED6	6	IDED10
7	PCICLK2	8	PREQ-0	7	IDED5	8	IDED11
9	PCICLK1	10	PCIRST-	9	IDED4	10	IDED12
11	INT-A	12	INT-D	11	IDED3	12	IDED13
13	INT-C	14	INT-B	13	IDED2	14	IDED14
15	GND	16	LINK/ACTIVE	15	IDED1	16	IDED15
17	LANTX-	18	LANRX-	17	IDED0	18	IDECBLID
19	LANTX+	20	LANRX+	19	IDEREQ	20	IDESA0
21	DUPLEX	22	VCC3-OUT	21	IDEIOW	22	IDESA1
23	GND	24	GND	23	IDEIOR	24	IDESA2
25	USBD3-	26	USBD2-	25	IDERDY	26	IDECS0
27	USBD3+	28	USBD2+	27	IDEACK	28	IDECS1
29	USBD1-	30	USBD0-	29	IDEINT	30	AIDELED
31	USBD1+	32	USBD0+	31	GND	32	GND
33	GND	34	GND	33	AD0	34	AD1
35	CTS2\	36	DSR2\	35	AD2	36	AD3
37	DTR2\	38	RXD2\	37	AD4	38	AD5
39	RI2\	40	RTS2\	39	AD6	40	AD7
41	TXD2\	42	DCD2\	41	CBE-0	42	AD8
43	TXDEN2	44	TXDEN1	43	AD9	44	AD10
45	CTS1\	46	DSR1\	45	AD11	46	AD12
47	DTR1\	48	RXD1\	47	AD13	48	AD14
49	RI1\	50	RTS1\	49	AD15	50	CBE-1
51	TXD1\	52	DCD1\	51	PAR	52	DEVSEL-
53	GND	54	GND	53	STOP-	54	IRDY-
55	GP30	56	GP31	55	GND	56	GND
57	GP32	58	GP33	57	TRDY-	58	CBE-2
59	GP34	60	GP35	59	FRAME-	60	AD17
61	GP36	62	GP37	61	AD16	62	AD19
63	GP20	64	GP21	63	AD18	64	AD21
65	GP22	66	GP23	65	AD20	66	AD23
67	GP24	68	GP25	67	AD22	68	CBE-3
69	GP26	70	GP27	69	AD24	70	AD25
71	GND	72	GND	71	AD26	72	AD27
73	VCC	74	KEY1	73	AD28	74	AD29
75	VCC	76	KEY0	75	PGNT-2	76	AD30

## 2.5 System Mapping

Memory Mapping		
Address	Description	Usage
0000:0000 - 9000:FFFF	System RAM	*
A000:0000 - A000:FFFF	EGA/VGA Video Memory	
B000:0000 - B000:7FFF	MDA RAM, Hercules graphics display RAM	
B000:8000 - B000:FFFF	CGA display RAM	
C000:0000 - C000:7FFF	EGA/VGA BIOS ROM	
C000:8000 - C000:BFFF	Boot ROM enable	
C000:C000 - C000:FFFF	Console Redirection enable	
D000:0000 - D700:FFFF	Expansion ROM space	
D800:0000 - DB00:FFFF	SPI FLASH Emulation Floppy A Enable	
DC00:0000 - DF00:FFFF	Expansion ROM Space	
E000:0000 - E000:FFFF	USB Legacy SCSI ROM space	
F000:0000 - F000:FFFF	Motherboard BIOS	*
FEFA:D000 - FFFF:F000	Standard OpenHCD USB Host Controller	*
FEFA:F800 - FFFF:FF00	Standard OpenHCD USB Host Controller	*
FEFA:F400 - FFFF:FF00	On board Ethernet Adapter	*
FEFA:E000 - FFFF:F000	Standard Enhanced PCI to USB Host Controller	*
FEFA:FC00 - FFFF:FF00	Standard Enhanced PCI to USB Host Controller	*

<b>I/O Mapping</b>		
<b>I/O Address</b>	<b>Owner</b>	<b>Usage</b>
0000h - 000Fh	DMA 8237-1	*
0010h - 0017h	COM 9	
0020h - 0021h	PIC 8259-1	*
0022h - 0023h	Indirect Access Registers (6117D configuration port)	*
002Eh - 002Fh	Forward to LPC BUS	
0040h - 0043h	Timer Counter 8254	*
0048h - 004Bh	PWM counter 8254	*
004Eh - 004Fh	Forward to LPC BUS	
0060h	Keyboard / Mouse data port	*
0061h	Port B + NMI control port	*
0062h - 0063h	8051 download 4k address counter	*
0064h	Keyboard/ Mouse status/ command port	*
0065h	WatchDog0 reload counter	*
0066h	8051 download 8bit data port	*
0067h	WatchDog1 reload counter	*
0068h - 006Dh	WatchDog1 control counter	*
0070h - 0071h	CMOS RAM port	*
0072h - 0075h	MTBF control register	*
0078h - 007Ch	GPIO port 0,1,2,3,4 default setup	*
0080h - 008Fh	DMA page register	*
0092h	System control register	*
0098h - 009Ch	GPIO direction control	*

00A0h - 00A1h	PIC 8259-2	*
00C0h - 00DFh	DMA 8237-2	*
00E0h - 00EFh	DOS 4G Page access	*
0170h - 0177h	IDE1(IRQ 15)	
01F0h - 01F7h	IDE0 (IRQ 14)	*
0220h - 0227h	COM8 Forward to LPC BUS	
0228h - 022Fh	COM7 Forward to LPC BUS	
0238h - 023Fh	COM6 Forward to LPC BUS	
0278h - 027Fh	Printer port (IRQ7, DMA 0)	*
02E8h - 02EFh	COM4 (IRQ 11)	*
02F8h - 02EFh	COM2 (IRQ3)	*
0338h - 033Fh	COM5 Forward to LPC BUS	
0376h	IDE1 ATAPI device control write only register	*
03E8h - 03EFh	COM3 (IRQ 10)	*
03F0h - 03F7h	Floppy Disk (IRQ6, DMA2)	
03F6h	IDE0 ATAPI device control write only register	*
03F8h - 03FFh	COM1 (IRQ 4)	*
0480h - 048Fh	DMA High page register	*
0490h - 0499h	Instruction counter register	*
04D0h - 04D1h	8259 Edge / level control register	*
0CF8h - 0CFFh	PCI configuration port	*
DE00h - DEFFh	On board LAN	*
FC00h - FC05h	SPI Flash BIOS control register	*
FC08h - FC0Dh	External SPI BUS control register	*

<b>IRQ Mapping</b>		
<b>IRQ#</b>	<b>Description</b>	<b>Usage</b>
IRQ0	System Timer	*
IRQ1	Keyboard Controller	*
IRQ2	Cascade for IRQ8 – 15	
IRQ3	Serial Port 2	*
IRQ4	Serial Port 1	*
IRQ5	USB	*
IRQ6	USB	*
IRQ7	Printer Port	*
IRQ8	Real Time Clock	*
IRQ9	USB/ Ethernet 10/100M LAN	*
IRQ10	Serial Port 3	*
IRQ11	Serial Port 4	*
IRQ12	Mouse	*
IRQ13	Math Coprocessor	*
IRQ14	Hard Disk Controller#1	*
IRQ15	Hard Disk Controller#2	*



<b>DMA Mapping</b>		
<b>DMA#</b>	<b>Description</b>	<b>Usage</b>
DMA0		
DMA1		
DMA2	Floppy Disk Controller	
DMA3		
DMA4		
DMA5		
DMA6		
DMA7		

## 2.6 Watchdog Timer

There are two watchdog timers in Vortex86SX/DX CPU. One is compatible with M6117D watchdog timer and the other is new. The M6117D compatible watchdog timer is called WDT0 and the new one is called WDT1.

We also provide DOS, Linux and WinCE example for your reference. For more technical support, please visit: <http://www.dmp.com.tw/tech> or download the PDF file:

<http://www.dmp.com.tw/tech/vortex86dx/>

## 2.7 GPIO (General Purpose Input / Output)

40 GPIO pins are provided by the Vortex86SX/DX for general usage in the system. Each GPIO pin is independent and can be configured as input or output, with or without pull-up/pull-down resistors.

We also offer DOS, Linux and WinCE example for your reference. For more technical support, please visit: <http://www.dmp.com.tw/tech> or download the PDF file:

<http://www.dmp.com.tw/tech/vortex86dx/>

## 2.8 SPI flash (Serial Peripheral Interface)

As SPI Flash (Serial Peripheral Interface) offers many benefits including: reduced controller pin count, smaller and simpler PCBs, reduced switching noise, less power consumption, and lower system cost

Many of users may consider using a formatted SPI flash to boot for the system or emulate SPI flash as Floppy (A: Driver or B: Driver). Then you must know how to set for this condition in CMOS Setup and boot up under DOS 6.22, X-DOS, DR-DOS and Free DOS.

For more technical support, please visit: <http://www.dmp.com.tw/tech> or download the PDF file: <http://www.dmp.com.tw/tech/vortex86dx/>

## 2.9 PWM (Pulse-width modulation)

Pulse-width modulation (PWM) of a signal or power source involves the modulation of its duty cycle, to either convey information over a communications channel or control the amount of power sent to a load.

The popular applications of pulse width modulation are in speed control of electric motors, volume control of Class D audio amplifiers or brightness control of light sources and many other power electronics applications.

The Vortex86DX SoC integrated 32 channels of PWM interface enabling the Automation, robotic industry to a New Age x86 SoC platform and we also offer the sample code of PWM which will guide the engineer to control the PWM functionality smoothly.

For more inquire of this sample code that please contact our sales team or mail to:

[info@icop.com.tw](mailto:info@icop.com.tw)

## 3.0 IDE to SD (Micro-SD)

Vortex86DX SoC also built-in simulation circuit to adapt SD to IDE in order to allow your system to recognize Micro-SD card as C: or D: Driver

**SD-1917:** 44 pins IDE to SD Adapter is an ideal solution for industrial PC or embedded system and 44 pins IDE to SD Adapter can be easily installed on all Vortex86DX CPU boards. You or your customers just do the BIOS setting and use SD-1917 to connect IDE connector of Vortex86DX boards directly.

For further inquiries of SD-1917, please contact ICOP sales team or mail to: [info@icop.com.tw](mailto:info@icop.com.tw) for your request.

### <BIOS setting>

- Get into the BIOS setup Utility
- Choose Primary IDE Pin Select: SD card
- Press “F10” to Save configuration changes and exit setup

### SD-1917



**SD-1917:** <http://www.icop.com.tw/pddetail.aspx?id=125&pid=4>

# Chapter 3

## Driver Installation

### VGA

The Vortex86DX processor also uses external Display Card “Volari™ Z9s” which is an ultra low powered graphics chipset with total power consumption at around 1-1.5 W. It is capable in providing VGA display output upto 1600x1200. With DVO interface, developers could easily connect flat Panel to support TFT and LVDS output.

Please download the Driver: [http://www.xgitech.com/sd/sd\\_download.asp](http://www.xgitech.com/sd/sd_download.asp)

### LAN

The Vortex86DX processor also integrated 10/100Mbps Ethernet controller that supports both 10/100BASE-T and allows direct connection to your 10/100Mbps Ethernet based Local Area Network for full interaction with local servers, wide area networks such as the Internet.

The controller supports: Half / Full-Duplex Ethernet function to double channel bandwidth, auto media detection.

### Operating system support

The SOM304RD-PI CPU module provides LAN drivers for DOS 6.22 Windows CE 5.0, CE 6.0, Windows 98, Windows XP Professional, Windows Embedded standard (XPE) and Windows 2000 (SP4).

Please get the drivers from the Driver CD which attached with the standard packing of SOM304RD-PI CPU module or please get it from DMP official website:

<http://www.dmp.com.tw/tech/vortex86dx/>

SOM304RD-PI CPU module also supports most of the popular Linux distributions, for more detail information, please visit DMP official website: <http://www.dmp.com.tw/tech/vortex86dx/>

# Appendix

## A. TCP/IP library for DOS real mode

DSock is a TCP/IP library for DOS real mode, which is used by RSIP. It provides simple C functions for programmer to write Internet applications. ICOP also provide Internet examples using DSock: BOOTP/DHCP, FTP server, SMTP client/server, HTTP server, TELNET server, Talk client/server, etc.

DSock provides a lot of example source code. Programmer can add Internet functions to their project easily and save development time. With a utility "MakeROM", programmer also can make a ROM image to fit their application, those examples can be seen in the following Application systems: Mity-Mite Serial Server, Web Camera Tiny Server and RSIP Serial Server.

DSock is free for All ICOP products using M6117D/Vortex86/Vortex86SX/Vortex86DX CPU and ICOP also provide the business version of DSock for those customers who are using other x86 CPUs.

If you would like to use DSock or business version of DSock, Please mail to [info@icop.com.tw](mailto:info@icop.com.tw) or contact your regional sales.

Please download the trial DSock software and Utilities from our website:  
<http://www.dmp.com.tw/tech/dmp-lib/dsock/>



## **B. SOM304RD-PI & SOM304DX-DEV-PI Schematic**

Schematic information can help baseboard designer to optimize exactly how each of these functions implements physically. Designer can place connectors precisely where needed for the application on a baseboard designed to optimally fit a system's packaging.

Please contact or e-mail our regional sales to get SOM304RD-PI CPU module and SOM304DX-DEV-PI Schematic.

## C. BIOS Default setting

If the system cannot be booted after BIOS changes are made, Please follow below procedures in order to restore the CMOS as default setting.

- Press “End” Key, when the power on



- Press <Del> to enter the AMI BIOS setup
- Press “F9” to Load Optimized Defaults
- Press “F10” to Save configuration changes and exit setup

# Warranty

This product is warranted to be in good working order for a period of one year from the date of purchase. Should this product fail to be in good working order at any time during this period, we will, at our option, replace or repair it at no additional charge except as set forth in the following terms. This warranty does not apply to products damaged by misuse, modifications, accident or disaster. Vendor assumes no liability for any damages, lost profits, lost savings or any other incidental or consequential damage resulting from the use, misuse of, originality to use this product. Vendor will not be liable for any claim made by any other related party. Return authorization must be obtained from the vendor before returned merchandise will be accepted. Authorization can be obtained by calling or faxing the vendor and requesting a Return Merchandise Authorization (RMA) number. Returned goods should always be accompanied by a clear problem description.