

### A Type

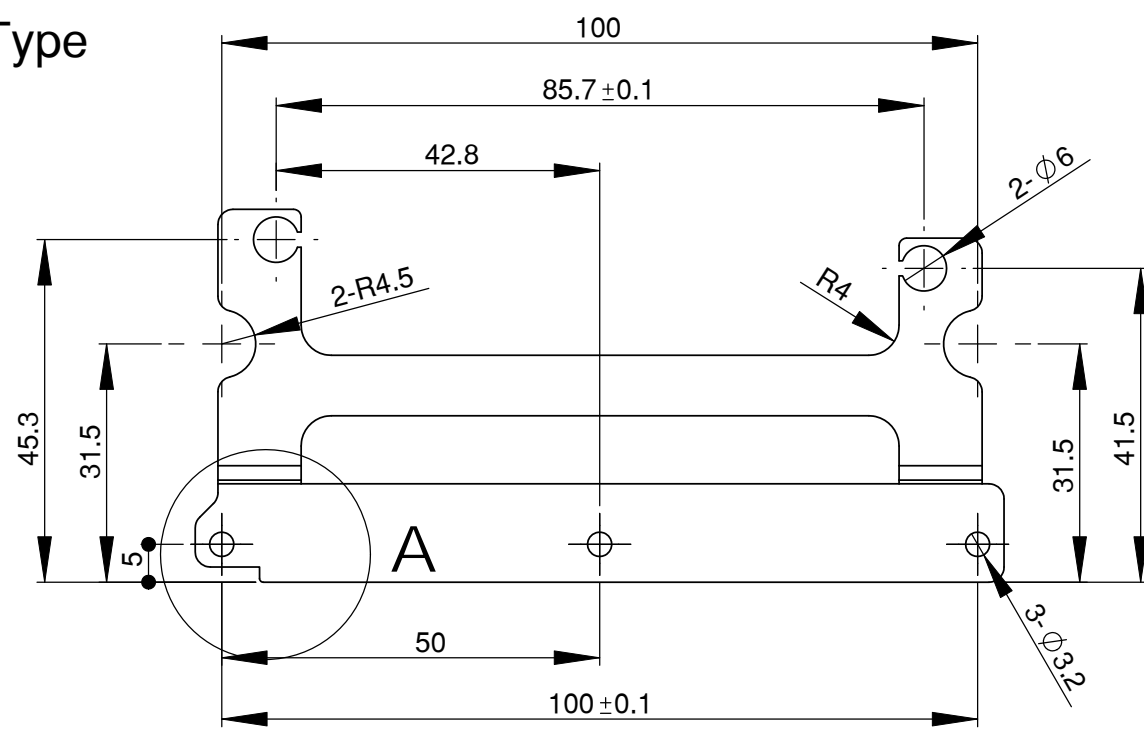

### B Type

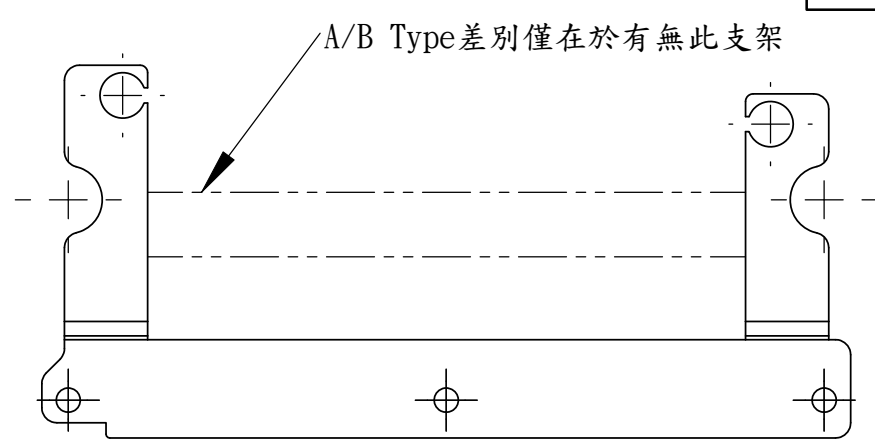

NOTE:  
 1. 材料:SECC (1.4t)  
 2. 未標柱之倒圓角皆為R 2.0mm  
 3. 未標註尺寸公差之尺寸請參照公差表  
 4. 成品請移除加工毛刺

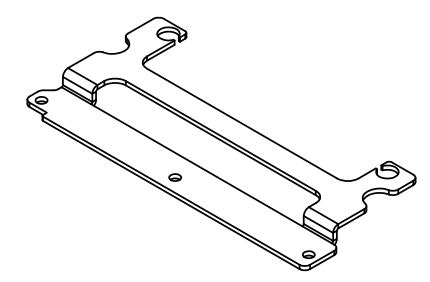
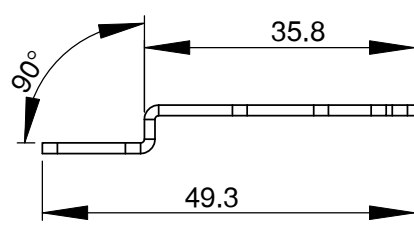
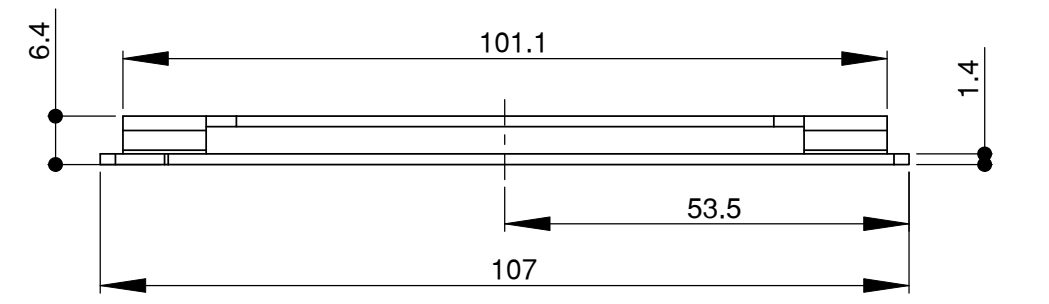

A Type (1:2)

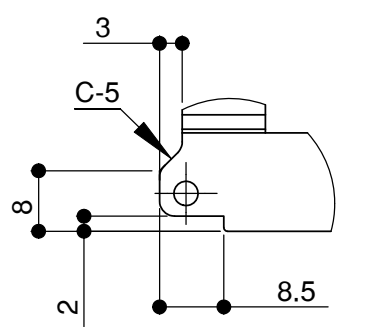
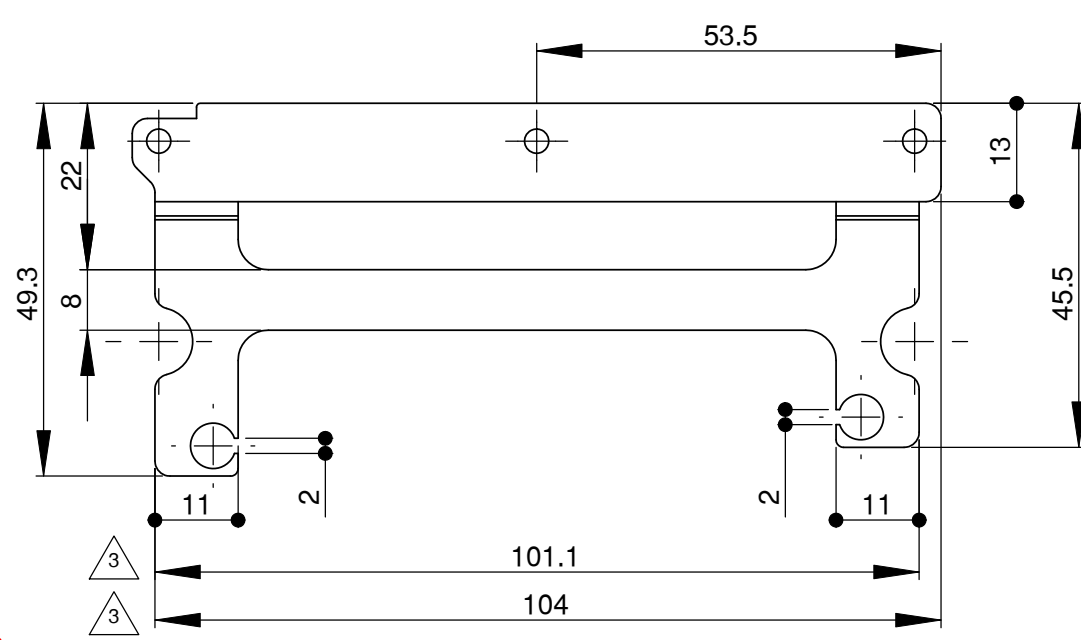

細部放大圖 A

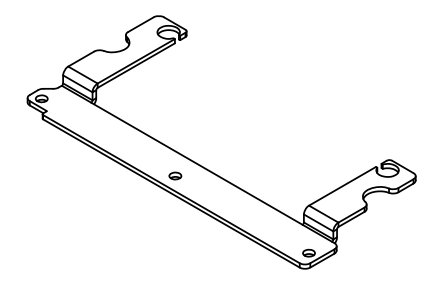

B Type (1:2)

批准  
2010.08.02  
研發部

DATE	APPD BY	DSN BY	ENGINEERING	CHANGE DESCRIPTION
08-02-2010		Derek		設變兩尺寸,原101.2mm改為101.1mm,104.05mm改為104mm
07-30-2010		Derek		因修改PCB裝配方式,故修改原D1.1設計與新增BType (另因設變處過多因此不另外標註修改尺寸位置)

BASIC RANGE		DRN BY	Derek	05-07-2010	DM & P ELECTRONICS INC.
.X	.XX	DSN BY	Derek	05-07-2010	
*****	*****	CKD BY			
ANGULAR ± DEG		APPD BY			THESE DRAWINGS AND SPECIFICATIONS ARE THE PROPERTY OF DM&P ELECTRONICS INC. NETWORKS. AND SHALL NOT BE REPRODUCED OR USED AS THE BASIS FOR THE MANUFACTURE OR SELL OF APPARATUSES OR DEVICES WITHOUT PERMISSION.
UNIT: MM	USED ON	PART NAME	Left_Bracket	PART NO.	*****
			ICE	SCALE: 1:1 (1:2)	PAGE: 1 OF 1