

EBOX-58 Series Mini PC

User's Guide



Copyright

The information in this manual is subject to change without notice for continuous improvement. All rights are reserved. Manufacturer assumes no responsibility for any inaccuracies that may contain in this document, and makes no commitment to update or to keep current information.

No part of this manual may be reproduced, copied, translated or transmitted, in whole or in part, in any form or by any means without the prior written permission of the DMP Electronics Inc.

©Copyright 2021 DMP Electronics Inc.

Trademarks Acknowledgment

Intel® Braswell E8000 & N3160 is the registered trademark of Intel Corporation.

DMP[®] is the registered trademarks of DMP Electronics Inc.

Other brand names, product names or trade names appearing in this document are the properties and registered trademarks of their respective owners. All names mentioned herewith are served for identification purpose only.

Safety Information

WARNING

- Do not expose EBOX to rain or moisture, in order to prevent shock and fire hazard.
- Never install EBOX in wet locations.
- Do not open cabinet to avoid electrical shock. Refer to the nearest dealer for qualified personnel servicing.
- Never touch un-insulated terminals or wire unless power adaptor and display monitor are disconnected.
- Locate EBOX as close as possible to the socket outline for easy access and to avoid force caused by entangling of your arms with surrounding cables from the EBOX.
- When using EBOX, avoid using or installing the modem to the serial port during a storm or a lightning.
- Do not use the modem or a telephone to report a gas leak in the vicinity of the leak.
- USB connectors are supplied with Limited Power Sources.

**DO NOT ATTEMPT TO OPEN OR TO DISASSEMBLE THE CHASSIS (ENCASING)
OF THIS PRODUCT. PLEASE CONTACT YOUR NEAREST DEALER
FOR SERVICING FROM QUALIFIED TECHNICIAN.**

Regulatory

FCC Class A Note

This equipment has been tested and found to comply with the limits for a Class A digital device, pursuant to Part 15 of the FCC Rules. These limits are designed to provide reasonable protection against harmful interference when the equipment is operated in a commercial environment. This equipment generates, uses and can radiate radio frequency energy and, if not installed and used in accordance with the instruction manual, may cause harmful interference in which case user will be required to correct interference at his own expense. Testing was done with shielded cables. Follow FCC regulations, user must use shielded cables with installation.

WARNING

This product complies with EN55032 class A. In a domestic environment, it may cause radio interference in which case the user may be required to take adequate measures.

Changes or modifications to this unit not expressly approved by the party responsible for compliance could void user's authority to operate the equipment.

This device complies with Part 15 of the FCC rules. Operation is subject to the following two conditions: (1) this device may not cause harmful interference, and (2) this device must accept any interference received, including interference that may cause undesired operation.

This digital apparatus does not exceed Class A limits for radio noise emissions from digital apparatus as set out in interference - causing equipment standard "Digital Apparatus", ICES-003 of the Department of Communications.

Manufacturer's Declaration of Conformity

This equipment has been tested and found to comply with the requirements of European Community Council Directives 2014/30/EU & 2014/35/EU relating to electromagnetic compatibility and product safety respectively.

Attention

This product has been designed and certified to comply with certain regulatory requirements pertaining to Information Technology Equipment. This product has not been designed for use as a medical device. Without limitation of the foregoing, this product is not intended and has not been certified for use in a hospital or clinical environment to diagnose, treat, or monitor patients under medical supervision, it is not intended and has not been certified to make physical or electrical contact with patients, nor to transfer energy to or from patients and/or to detect such energy transfer to or from patients.

Purchase Agreement

Purpose:

In accordance to the general commercial conduct of Trust and Fair Trade, herewith below is the agreement for the protection for both parties, DMP and Users in pursuant of trading.

Product Description:

EBOX-58 Series industrial fanless PC integrates an Intel® Braswell E8000 or N3160 series processor. Supports memory up to 8GB DDR3L, Dual Giga LAN, Dual RS-485/RS-232 up to 4 ports, etc. Suitable platform for IoT, M2M, Industry 4.0, Home Automation Security, Point-of-sales, Public transportation and many more.

Distribution Convention:

1. This Product includes a PC and a power supply unit. Upon receiving this product, please refer to user manual to check for the contents and appearance of this product; contact the nearest dealer or DMP office for any defective or missing parts immediately. The supplier will not be responsible for any reported discrepancy there after the expiration period of 3-days from the received date.
2. In consideration of transportation and the cost of storage, the supplier provides to the distributors a warranty of 12 months. This warranty covers the failure caused by hardware breakdown. (excluding hard drives), but does not cover the act of misuse and mishandling.
3. The supplier will not accept unknown post, therefore if you wish to repair or to return your goods, please contact your nearest dealer to make your declaration, at the same time, apply for an RMA number (RMA stands for Return Merchandise Authorization), and ask for RMA form then fill-up for authorization.
4. The freight for return goods for repair will follow the International customary practice and convention. Both parties is to pay for freight of one shipment each. The shipper is required to prepay the freight from the place of origin (This means that the returnee/user covers the freight for return goods, while the Supplier covers the freight for goods after the repair).
5. Obsolete warranty is referred to as: (1) Expiration of warranty or (2) Damage due to misuse within warranty. The Supplier will be taken into consideration of the circumstances, to provide repair service with charges expense for obsolete warranty. This expense includes the cost of material and the cost of labor.

Note: If there is other particular issue, not listed in the above conditions, both parties agreed to follow General Law of Commerce with fair and reasonable discussion in handling and resolving the argument.

Contents

Chapter 1

- 07 Unpacking EBOX Mini PC

Chapter 2

- 10 EB-58 Series no COM ports model types
- 11 EB-58 Series COM ports model types
- 12 EB-58 Internal description
- 13 Appearance Diagram
- 14 System Specifications

Chapter 3

- 16 BIOS Reconfiguring
- 16 Hot Key
- 17 UEFI PXE diskless boot setting
- 18 Legacy PXE diskless boot setting
- 19 Drivers Installation Guide
- 19 Chipset driver
- 20 Graphic driver
- 21 Audio driver
- 22 LAN driver
- 23 TXE driver

Chapter 4

- 25 Onboard Connectors Summary
- 25 Pin Assignments

Chapter 5

- 29 Taking Care of EBOX
- 30 Troubleshooting

Chapter 6

- 33 Terms and Condition
- 33 Warranty
- 33 Service and Support
- 33 Return Merchandise Authorization (RMA) Policy
- 33 Shipping Policy

Chapter 1

Unpacking EBOX Mini PC

Component List:

Item No.	Description	Quantity
1	EBOX-58 Series Mini PC	x1
2	Power Adaptor 40W; Vin: 100~240V AC 50~60Hz	x1
3	Power cable (available US, UK, EU, AU types)	x1
4	VESA screw	x4
5	SATA SLIM 7+15 pin cable	x1

Note: The accessories are subject to change without immediate notice.

Check before Use

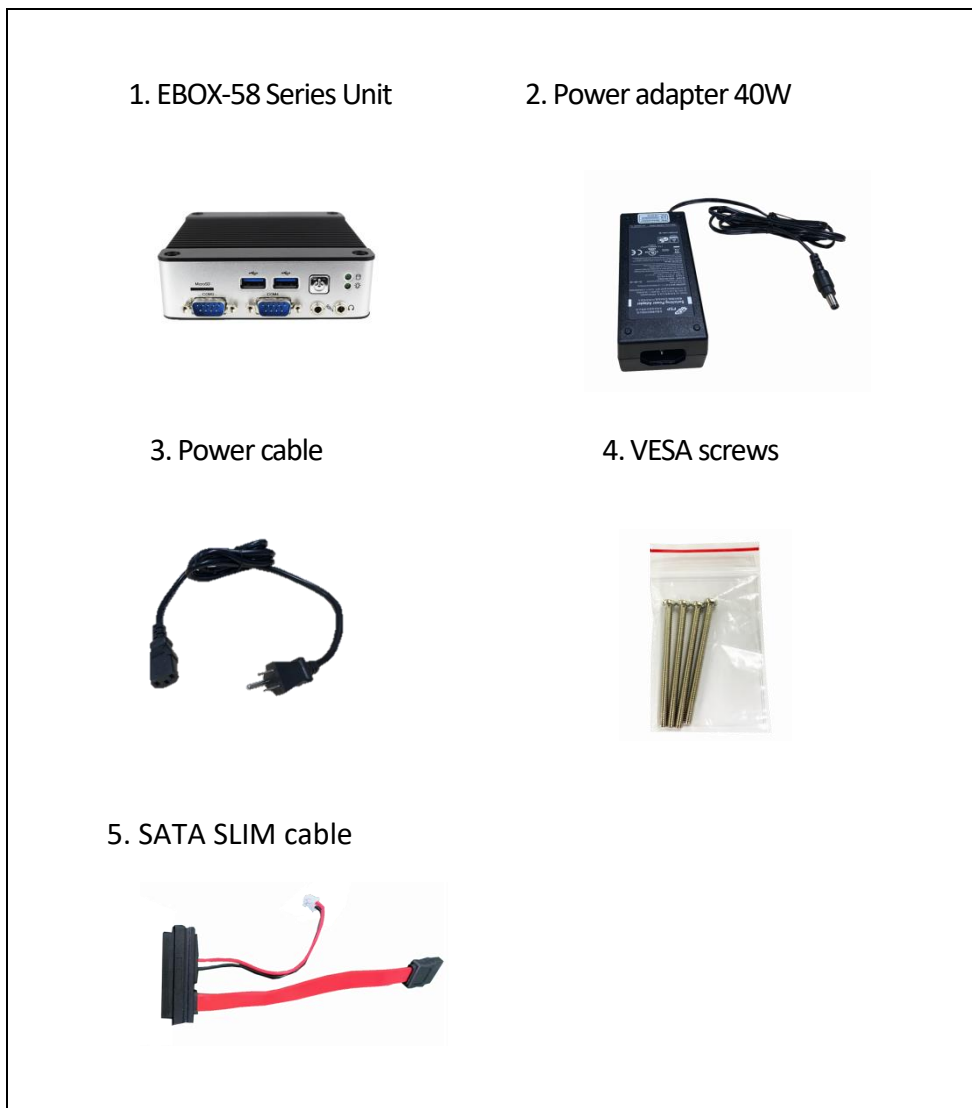

Preface

EBOX-58 Series Mini PC

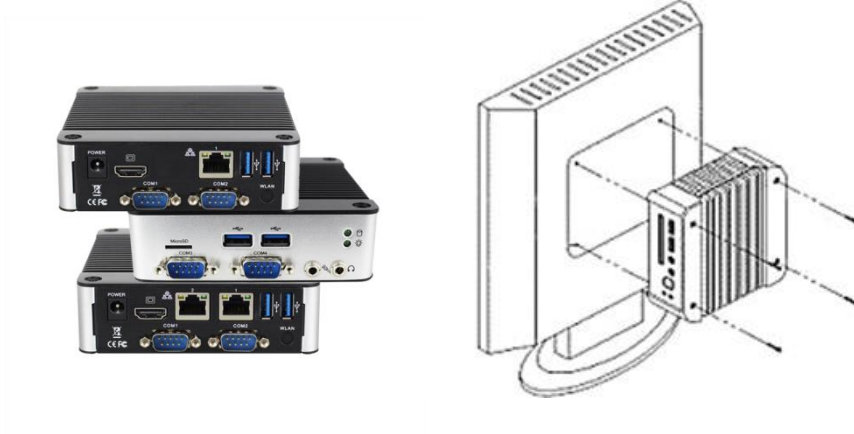

EBOX-58 Series industrial fanless PC integrates an Intel® Braswell E8000 or N3160 series processor. Supports memory up to 8GB DDR3L, Dual Giga LAN, Dual RS-485/RS-232 up to 4 ports, etc. Suitable platform for IoT, M2M, Industry 4.0, Home Automation Security, Point-of-sales, Public transportation and many more.

EBOX-58 Series can be attached to any VESA mounting fixture; allowing it to be securely mounted onto desks, walls, or buildings, and thereby optimizes your work area. It can also attach directly to any size LCD monitor, for the use at trade shows, presentations, promotions, etc. With FANLESS design, it's ideal to be used in the environment where temperature demand is critical.

EBOX-58 Series supports Win 10, Win 10 IoT, Win 7, WES7, Linux Ubuntu and Debian to meet ready-to-market demand and provide competitive advantages for customers.

Chapter 2

EBOX-58 Series no COM ports model types:

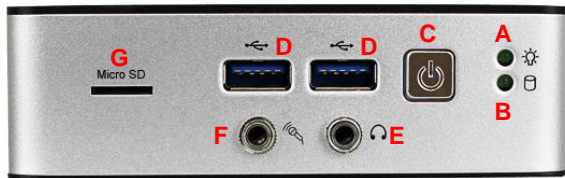

Front Panel

A: Power LED

Green flashing LED indicates SATA storage activity

B: SATA LED

LED lights up when the system is turned on

C: Power Button

System power on/off

D: USB 3.0 ports

External USB devices use

E: Line Out

Audio output

F: Mic In

Microphone input

G: Micro SD Card Slot

Expanded storage Micro SD use

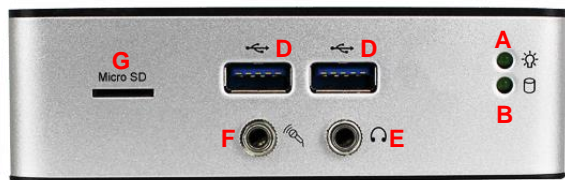

Back Panel

H: RJ-45 LAN Jack

Realtek 8111H GigaLAN

I: HDMI Output port

HDMI display output

J: Power Jack

Volt: DC +8V~+26V



EBOX-58 Series COM ports model types:

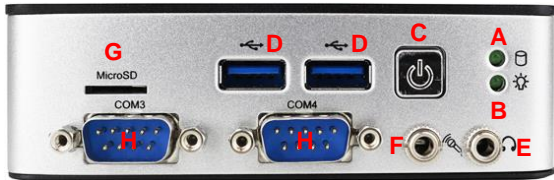

Front Panel

A: Power LED

Green flashing LED indicates SATA storage activity

B: SATA LED

LED lights up when the system is turned on

C: Power Button

System power on/off

D: USB 3.0 ports

External USB devices

E: Line Out

Audio output

F: Mic In

Microphone input

G: Micro SD Card Slot

Expanded storage Micro SD use

H: COM ports

RS-232 x2

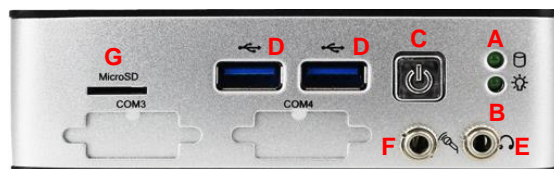

*Model types with Auto Power On features do not have reset button.

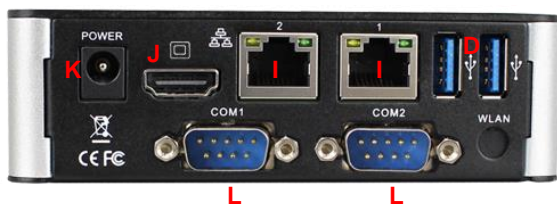

Back Panel

I: RJ-45 LAN Jack

Realtek 8111H GigaLAN

J: HDMI Output port

HDMI display output

K: Power Jack

Volt: DC +8V~+26V

L: COM ports

RS-232 x2 or RS-485 x2



EBOX-58 Internal description

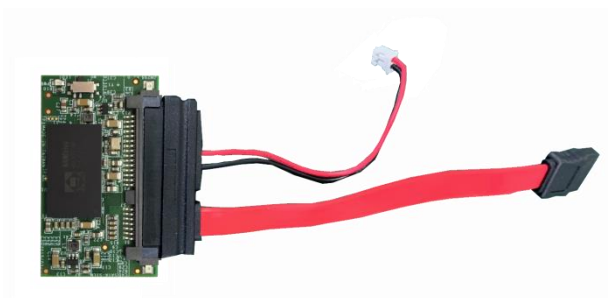
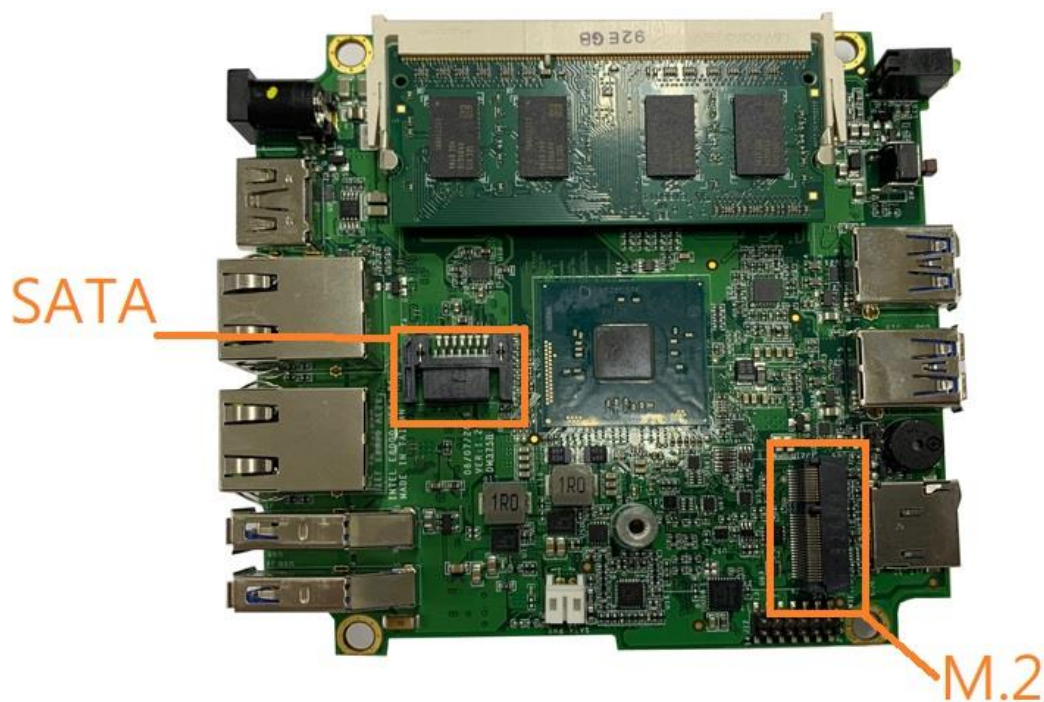

Host interface

- WiFi : PCIe + Bluetooth : USB
WiFi & BT can be use at position 1.
- WiFi : PCIe
Only WiFi can be use at position 2.

DGF109A M.2 WiFi/ BT Module



To use SATA SLIM DOM as a boot drive, connect SATA SLIM 7+15 pin cable and place SATA SLIM DOM under the PCB, fixed at the bottom.

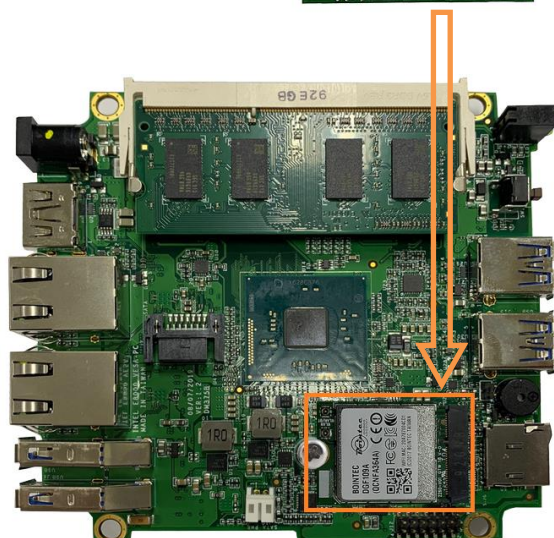
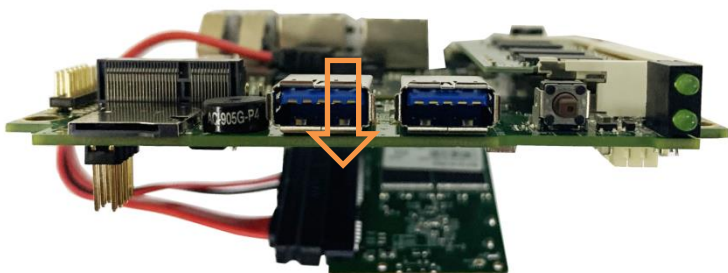

Optional item DGF109A M.2 Wi-Fi/BT module info www.compactpc.com.tw

Appearance Diagram

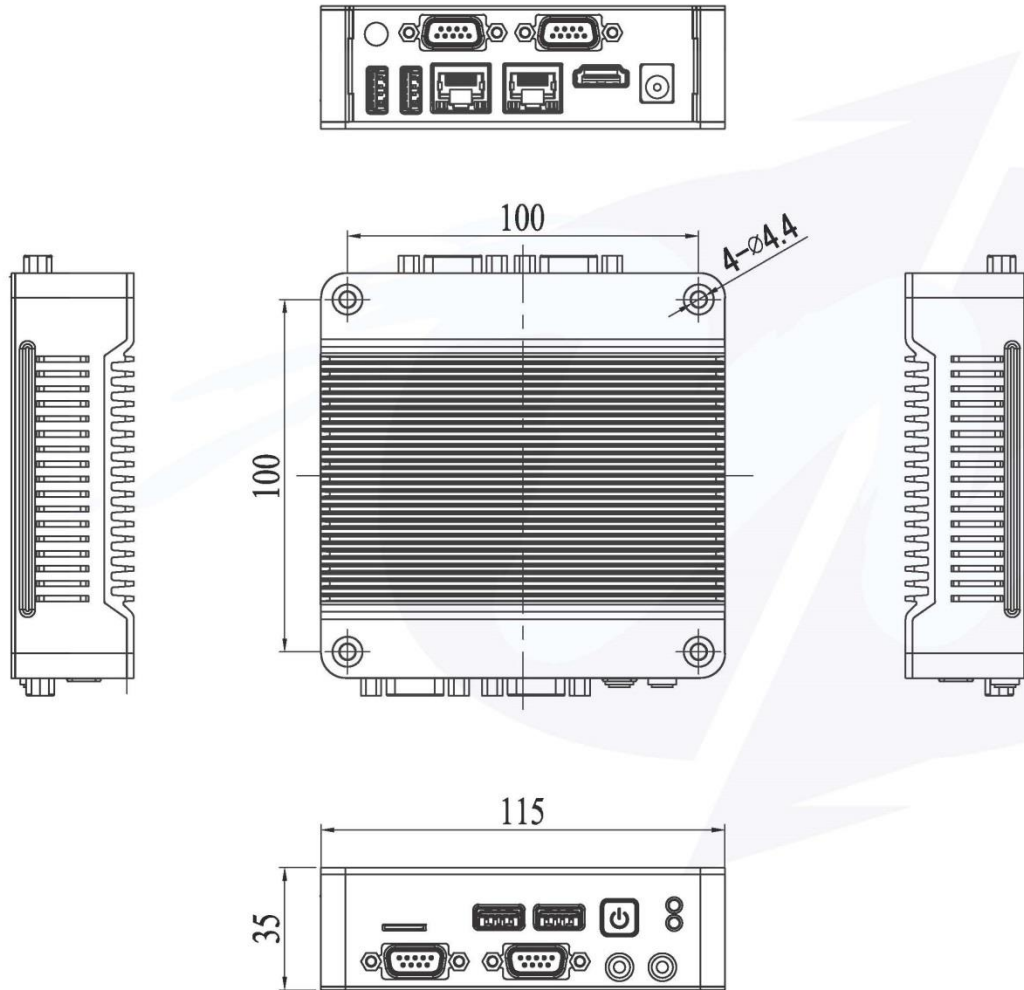

System Specifications

Processor	Intel® Atom® x5-E8000 Quad Core 1.04GHz, 2.00GHz (Burst) Intel® Celeron® N3160 Quad Core 1.6GHz, 2.24GHz (Burst)
BIOS	AMI UEFI BIOS
Memory	SO-DIMM, DDR3L-1600MHz up to 8GB
Storage	SATA SATA Gen3 x1, SATA SLIM 7+15 pin internal
	Micro SD Micro SD Slot x1 (Micro SD, SDXC)
Display	HDMI V1.4b (MAX. 3840 × 2160 pixels)
USB	USB V3.0 x4 (Front x2, Rear x2)
HD Audio	Realtek ALC262VD Mic-in & Line-out
Ethernet	Realtek RTL8111H GBE x2, RJ45 x2
COM	D-Sub 9-pin up to RS-232 x4/RS-485 x2/TTL (Optional)
Extension I/F	M.2 2230 E Key x1 (WiFi/BT Module use)
Power requirement	DC +8V~+26V
Dimension	115 x 115 x 35mm
Mounting	VESA 100 x 100mm/DIN Rail Support (Optional)
New Weight	510g
Operating Temp	0~60°C
Security Support	TPM 2.0, Infineon SLB9665VQ2.0 (Optional)
Certifications	CE, FCC, VCCI
OS support	Win 10, Win 10 IoT, Win 7, WES7, Linux Ubuntu, Debian

Order information

Model Type	CPU	– LAN	D-Sub 9-pin I/O	TPM	– Auto Power On
EB-58	E: E8000	– L2: LAN x2	C2: RS-232 x2	F: Excluded	– AP: Support
	N: N3160	– L1: LAN x1	C4: RS-232 x4 F2: RS-232/RS-485 x2 F4: RS-485 x2 NN: None	T: Included	

Chapter 3

BIOS Reconfiguring

Load Default Setting

1. To reconfigure the hardware, press during unit boot up to enter BIOS menu.

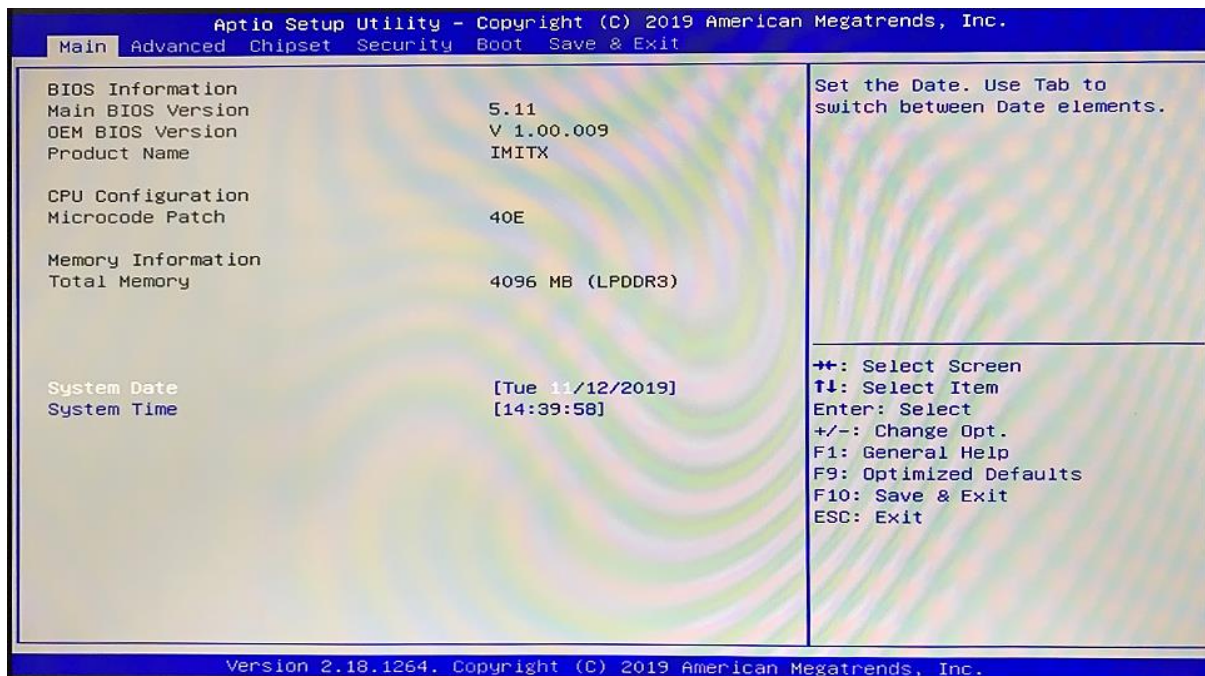

2. Move to "Save & Exit" → Restore Defaults, press Enter and select YES to execute.

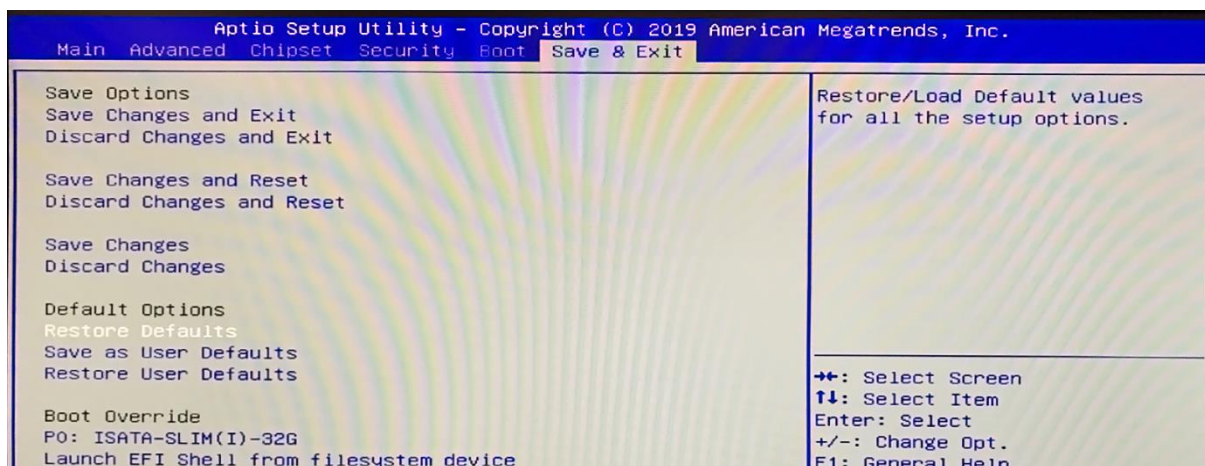

3. After setting, press "F10" key to save and reboot EBOX.

Hot key

Press <F11> during unit boot up, a select menu will appear. Use direction key to select boot device.

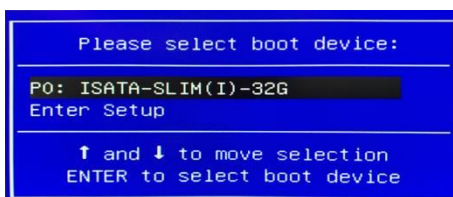

UEFI PXE diskless boot setting

1. Press during unit boot up to enter BIOS menu.
2. Move to “Advanced” → “CSM Configuration” and press Enter.

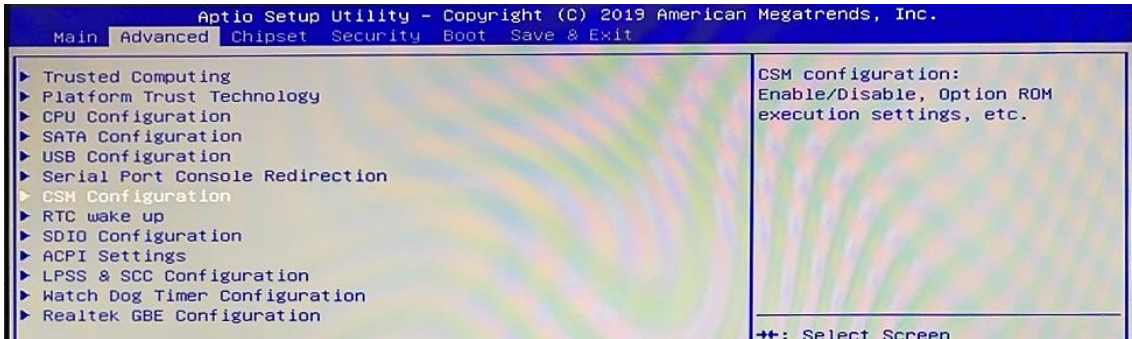

3. Move to “Network” and select “UEFI”.

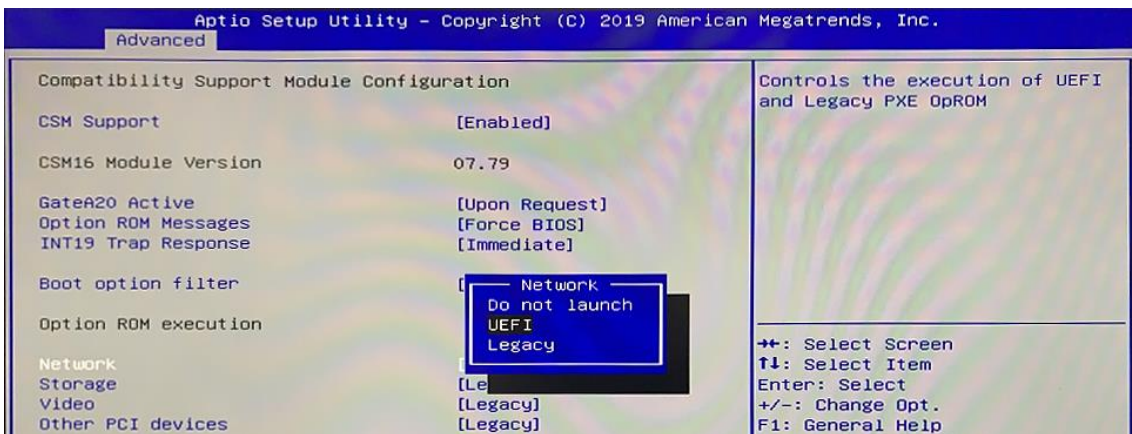

4. Move to “Boot” → FIXED BOOT ORDER Priorities → Boot Option #1 → select “UEFI Network”.

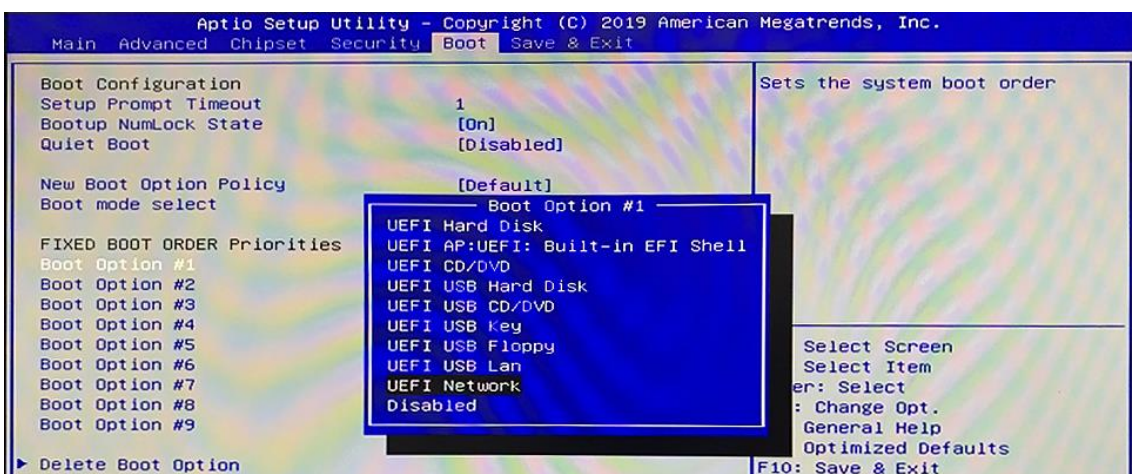

5. Press “F10” to save and reboot EBOX to activate UEFI PXE diskless boot.

LEGACY PXE diskless boot setting

1. Press during unit boot up to enter BIOS menu.
2. Move to “Advanced” → “CSM Configuration” and press Enter.



3. Move to “Network” and select “Legacy”.

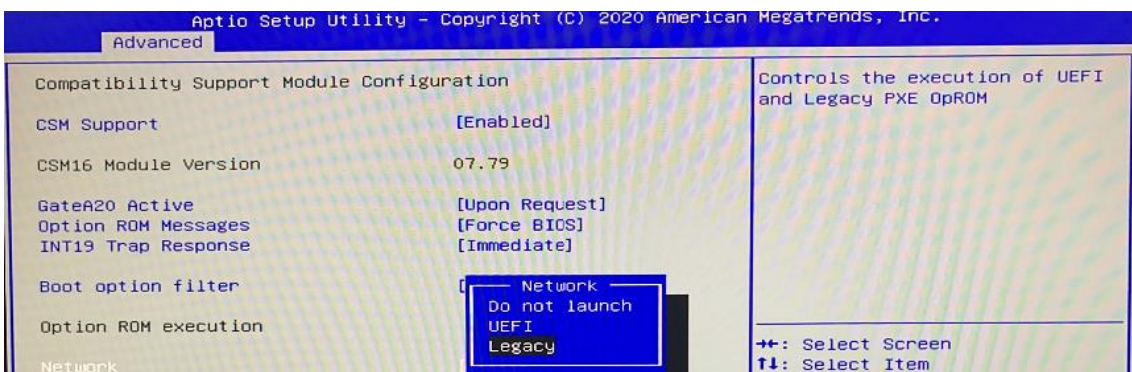

4. Move to “Boot” → “Boot mode select” → select “LEGACY”.

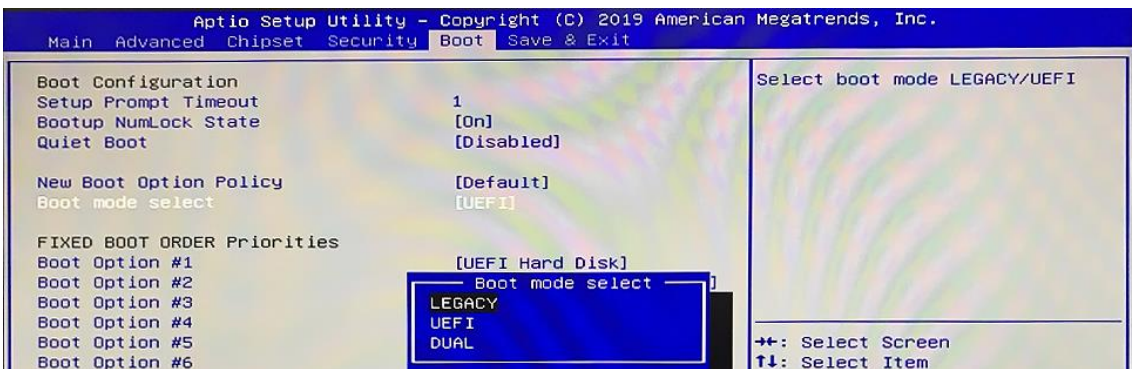

5. Move to “Boot” → FIXED BOOT ORDER Priorities → Boot Option #1 → select “Network”.

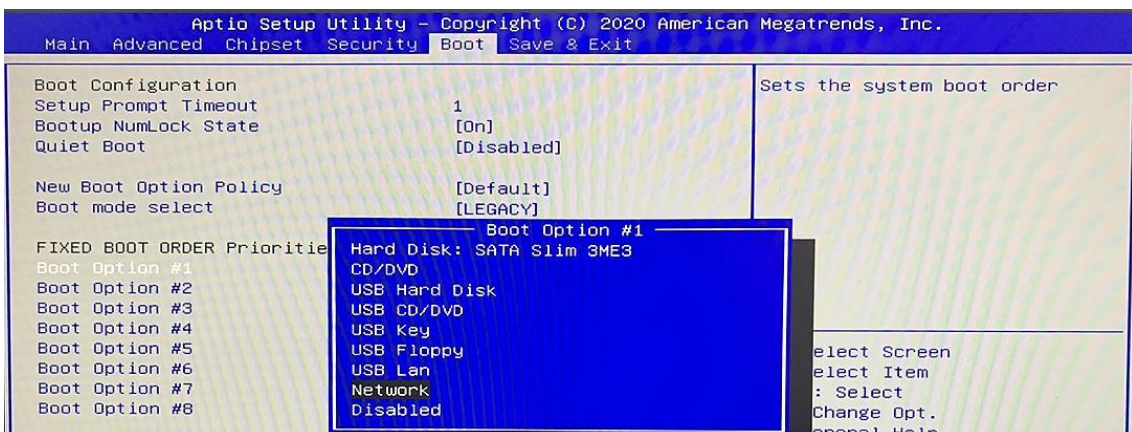

6. Press “F10” key to save and reboot EBOX to activate LEGACY PXE diskless boot.

Drivers Installation guide

Under Windows 10, the following drivers need to be installed manually.

1. Chipset
2. Graphic
3. Audio
4. LAN
5. TXE

Please download above drivers from EBOX website.

Chipset driver: (Intel® Chipset Device Software)

1. Unzip Chipset file, execute SetupChipset.exe, and then click “Next” to continue.

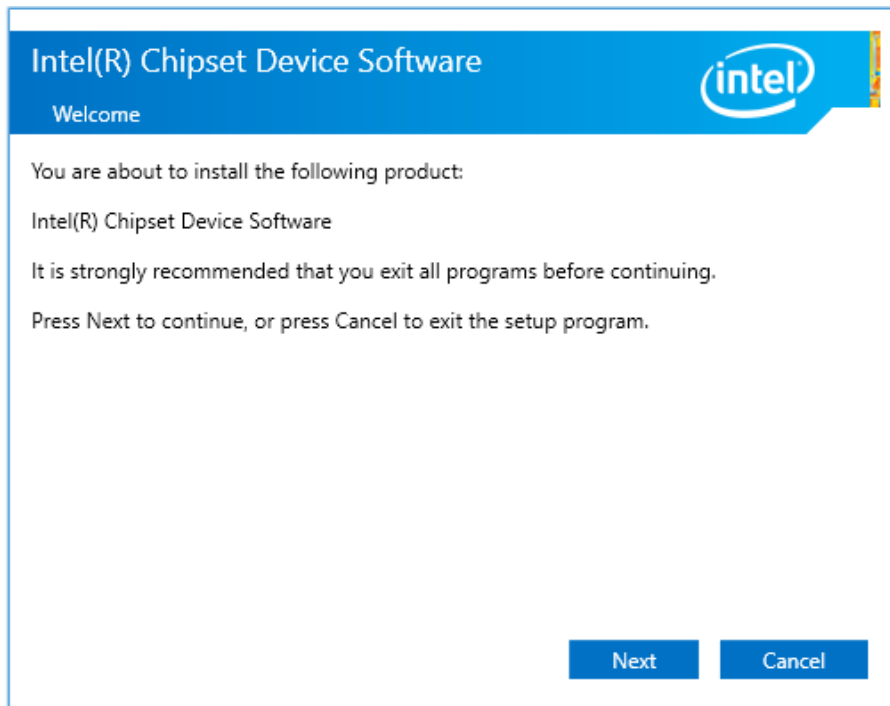

2. A license agreement message will pop out, click Accept and install.
3. Click Finish to complete the setup process.

Graphic driver:

1. Unzip Graphic file and execute igxpin.exe, then click “Next” to continue.

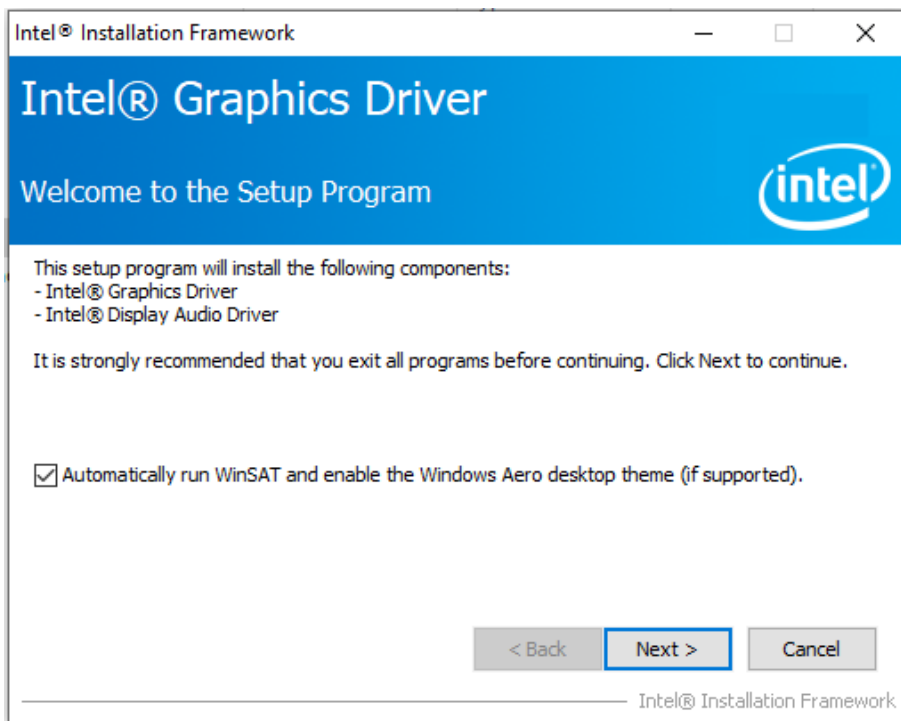

2. A license agreement message will pop out, click Accept and install.
3. After installed, select “Yes, I want to restart this computer now” and click Finish to reboot.

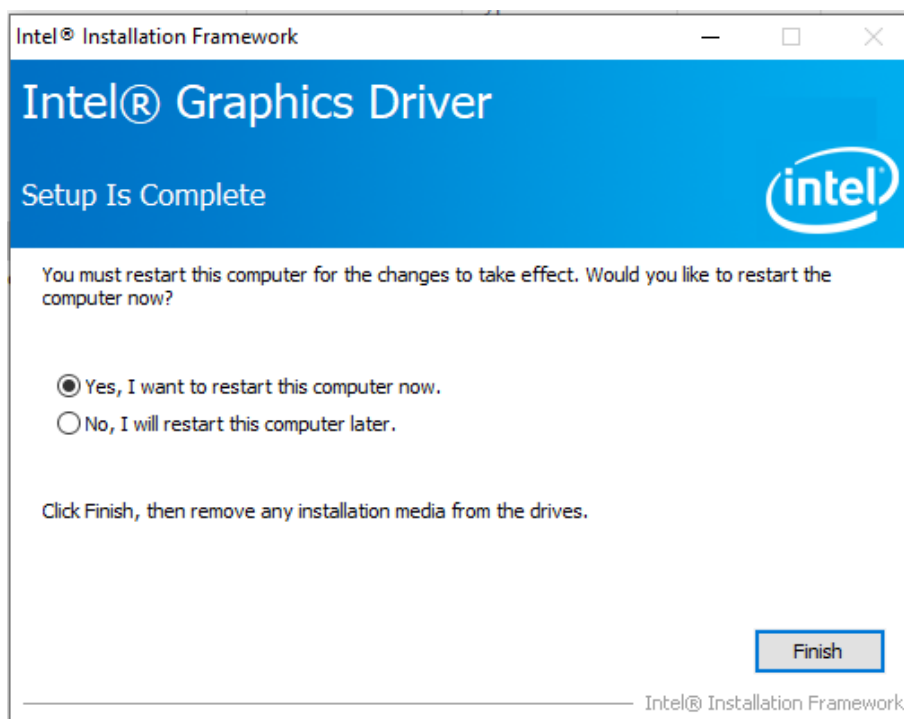

Audio driver:

1. Unzip Audio file, execute Setup.exe, and then click “Next” to install.

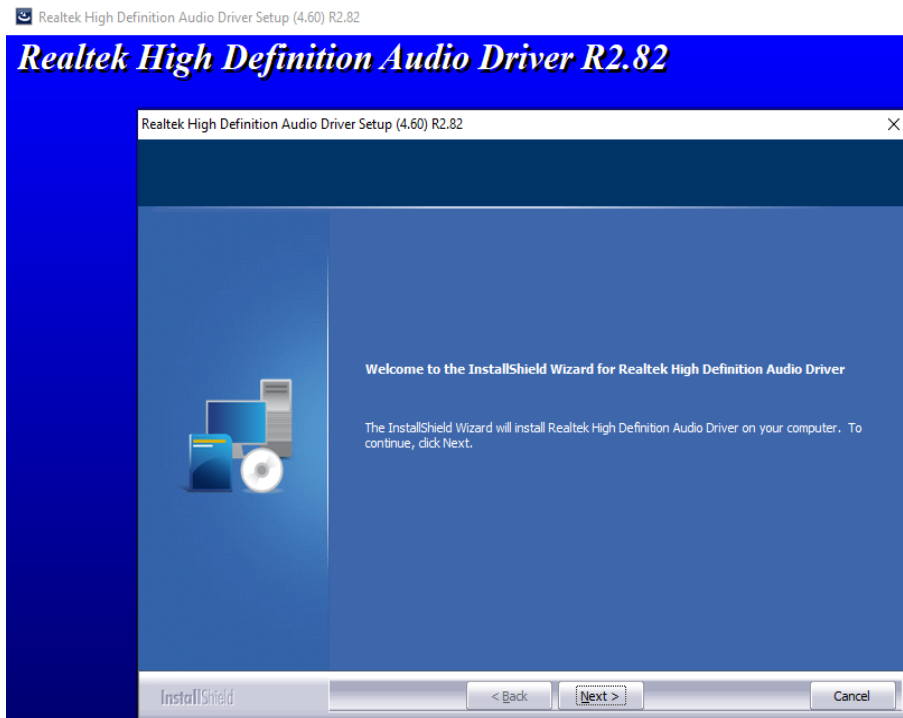

2. After installed, select “Yes, I want to restart this computer now” and click Finish to reboot.



LAN driver:

1. Unzip LAN file, execute Setup.exe and then click “Next” to install.

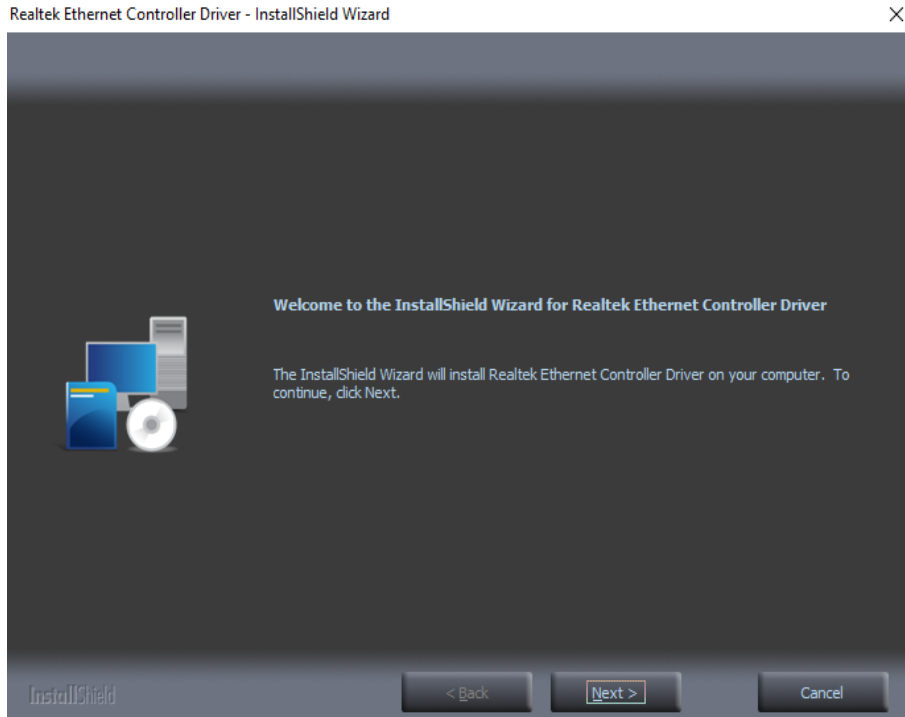

2. After installed, click “Finish” to exit the wizard.

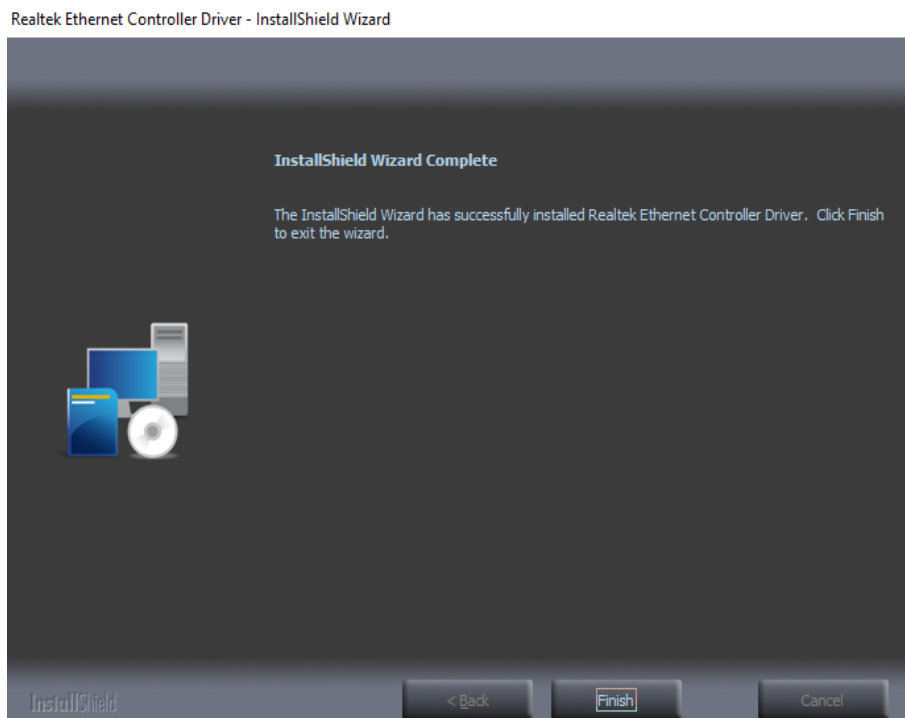

TXE driver: (Intel® Trusted Execution Engine)

Trusted Execution Engine is a hardware technology, primary goals are attestation of authenticity of a platform and its operating system.

1. Unzip TXE file, execute SetupTXE.exe and click “Next” to install:

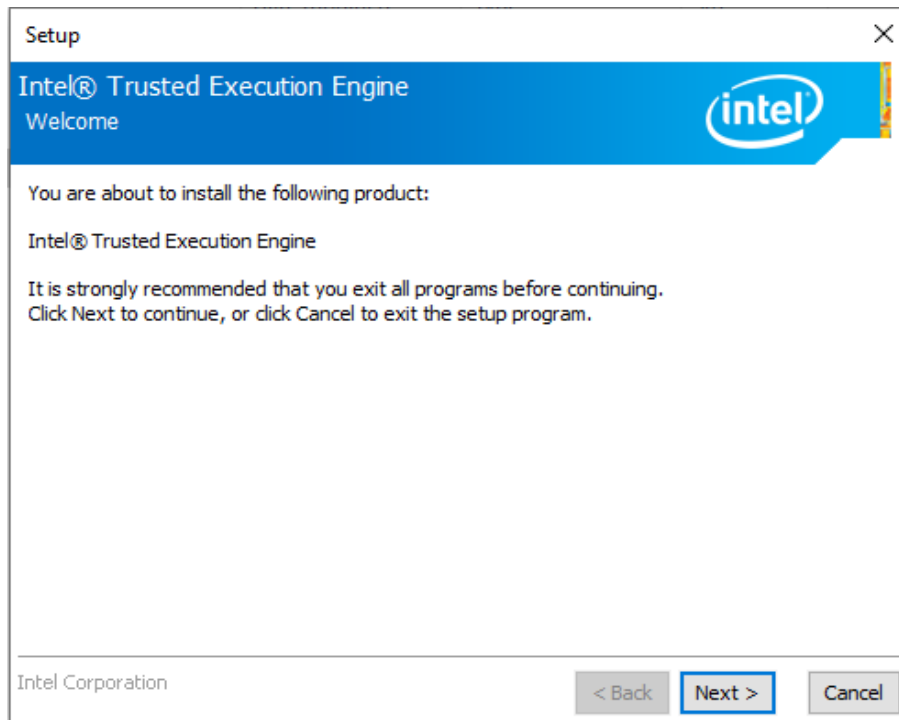

2. Check “I accept the term in the License Agreement and click “Next” to install.

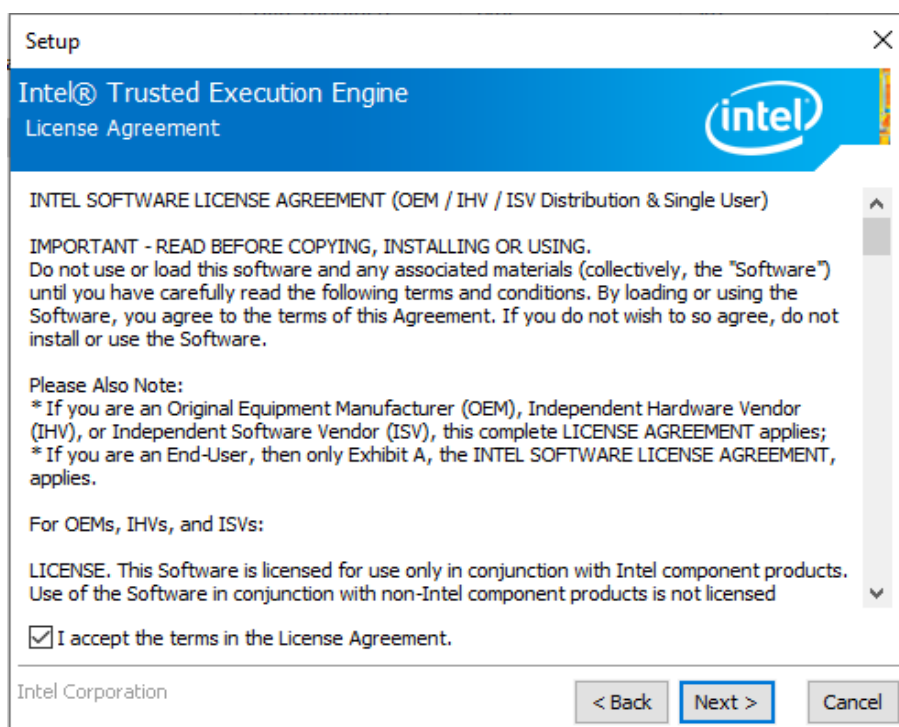

3. Click “Finish” after successfully installed.

Chapter4

Onboard Connectors Summary

Summary Table for CPU Board

No.	Description	Type of Connections	Pin nbrs.
J1	HDMI	HDMI connector	19-pin
J2	Power DC Jack	DC Jack connector	2-pin
J3, J4	Ethernet	G-LAN RJ45 connector	8-pin
J5, J6	USB 3.0	USB 3.0 connector	9-pin
J7	SATA	SATAIII port connector	7-pin
J8 ~ J9	RS-232 x2/RS-485 x2	DB9 header	9-pin
J10 ~ J11	RS-232 x2	DB9 header	9-pin
J12	SATA power output	2.54mm 4-pin header	4-pin
J14, J15	USB 3.0	USB 3.0 connector	9-pin
J17	Micro SD	Micro SD card slot	8-pin
J19	Line out	Audio jack	2-pin
J20	Mic in	Audio jack	2-pin
J21	M.2	M.2 connector	75-pin

Pin Assignments

J1: HDMI

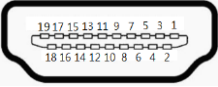
	Pin #	Signal Name	Pin #	Signal Name
	1	TMDS_Data2+	11	TMDS_CLK Shield
	2	TMDS_Data2_Shield	12	TMDS_CLK-
	3	TMDS_Data2-	13	CEC
	4	TMDS_Data1+	14	Reserved
	5	TMDS_Data1_Shield	15	SCL
	6	TMDS_Data1-	16	SDA
	7	TMDS_Data0+	17	DDC/CEC_GND
	8	TMDS_Data0_Shield	18	+5V Power
	9	TMDS_Data0-	19	Hot Plug Detect
10	TMDS_CLK+			

J2: DC Power Input

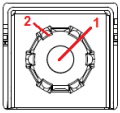
	Pin #	Signal Name
	1	+12VDC
	2	GND

J3, J4: LAN: RJ-45 connector

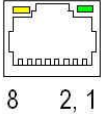
	Pin #	Signal Name	Pin #	Signal Name
	1	TP0+	5	TP2-
	2	TP0-	6	TP1-
	3	TP1+	7	TP3+
	4	TP2+	8	TP3-

J5, J6: USB 3.0 connector

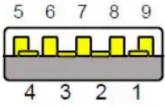
	Pin #	Signal Name	Pin #	Signal Name
	1	5V	6	Receive+
	2	DATA-	7	GND
	3	DATA+	8	Transmit-
	4	GND	9	Transmit+
5	Receive-			

J12: SATAIII connector

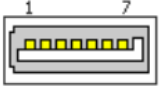
	Pin #	Signal Name	Pin #	Signal Name
	1	GND	5	Receive-
	2	Transmit+	6	Receive+
	3	Transmit-	7	GND
	4	GND		

J8~J11: 9-pin D-Sub connector

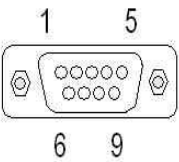
	Pin #	Signal Name	Pin #	Signal Name
	1	DCD/ RS-485-	6	DSR
	2	RXD/ RS-485+	7	RTS
	3	TXD	8	CTS
	4	DTR	9	RI
5	GND	--	--	--

J14, J15: USB 3.0 connector

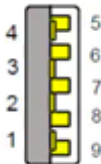
	Pin #	Signal Name	Pin #	Signal Name
	1	5V	6	Receive+
	2	DATA-	7	GND
	3	DATA+	8	Transmit-
	4	GND	9	Transmit+
5	Receive-			

J21: M.2 E Key

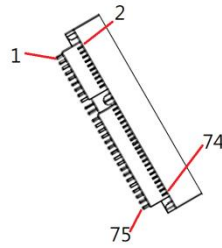

M.2 SOCKET-1: KEY-E CONNECTOR

	Pin N/B		Pin N/B
GND_1	1		
USB_D+	3	2	3.3V_2
USB_D-	5	4	3.3V_4
GND_7	7	6	LED1_N
SDIO_CLK	9	8	PCM_CLK/I2S_SCK
SDIO_CMD	11	10	PCM_SYNC/I2S_WS
SDIO_DATA0	13	12	PCM_IN/I2S_SD_IN
SDIO_DATA1	15	14	PCM_OUT/I2S_SD_OUT
SDIO_DATA2	17	16	LED2_N
SDIO_DATA3	19	18	GND_18
SDIO_WAKE_N	21	20	UART_WAKE_N
SDIO_RESET_N	23	22	UART_RX
CS		PS	
GND_33	33	32	UART_TX
PETP0	35	34	UART_CTS
PETN0	37	36	UART_RTS
GND_39	39	38	PESERVED_38
PERP0	41	40	PESERVED_40
PERPNO	43	42	PESERVED_42
GND_45	45	44	COEX3
REFCLKP0	47	46	COEX2
REFCLKN0	49	48	COEX1
GND51	51	50	SSCLK
CLKREQ0_N	53	52	PERST0_N
PEWAKE0_N	55	54	PESERVED_W_DISABLE_N
GND_57	57	56	W_DISABLE1_N
PESERVED_2ND_PETP1	59	58	I2C_DATA
PESERVED_2ND_PERN1	61	60	I2C_CLK
GND_63	63	62	ALERT
PESERVED_2ND_PERP1	65	64	RESERVED_64
PESERVED_2ND_PERN1	67	66	UIM_SWP/PERST1_N
GND_69	69	68	UIM_PWR_SNK/CLKREQ1_N
PESERVED/REFCLKN1	71	70	UIM_PWR_SRC/GPIO1/PEWAKE1_N
PESERVED/REFCLKP1	73	72	3.3V_72
GND_75	75	74	3.3V_74

Chapter 5

Taking Care of EBOX

This section provide guidelines on using EBOX-58 Series – Safe using, Storing and Handling.

Storing

- ▶ Do not place EBOX in a location that is subject to:
 - Heating sources, such as stove, oven, heater, radiator or air duct
 - Direct contact from sunlight
 - Rain or moisture area
 - Excessive dust accumulation area
 - High humidity place
 - Constant or occasional mechanical movement, vibration or shock
 - Strong magnets or magnetic fields or magnetically unshielded speakers
 - Out of the operating temperature
- ▶ Do not place other electronic device or electrical equipment near EBOX.
The electromagnetic field of EBOX may cause interference subjecting to malfunction.
- ▶ Provide adequate air ventilation (circulation) to prevent internal buildup of heat.
Do not place EBOX near behind the curtains or draperies, between books that block its ventilation slots.
Leave a space with at least 8 inches (20cm) behind the sides and back panel of the EBOX.
- ▶ Change of environmental temperature:
Problems may occur with a sudden change of environmental temperature.
If the EBOX is brought directly from a cold location to a warm place, moisture may condense inside EBOX.
Turn off the device and contact your nearest dealer.
- ▶ Check the surrounding appliance(s) before using EBOX. Since EBOX uses high-frequency radio signal.
It may interfere with radio or TV reception causing interference or poor signal display.
When happens, relocate the EBOX by a suitable distance away from it.
- ▶ Do not drop EBOX from working table nor place heavy objects on top of it.

Cleaning EBOX

- ▶ Clean EBOX with a soft, dry cloth or a soft cloth lightly moistened with a mild detergent solution.
- ▶ Do not use any type of abrasive pad, scouring powder, or solvent such as alcohol or benzene, as these may damage the finish of EBOX.
- ▶ When a solid object falls or a liquid spills onto EBOX, turn off EBOX immediately;
unplug LAN and power cables. Contact your dealer to check the EBOX before you use it again.
- ▶ Always disconnect the power cord from the power source before cleaning EBOX.

Troubleshooting

This section describes the techniques of resolving some basic problems that you encounter when using EBOX. For more troubleshooting guidelines, please contact your nearest dealer for technical support.

Troubleshooting EBOX

A. EBOX does not start –

- ▶ Make sure EBOX is properly secured and plugged into a power source before it is turned on.
- ▶ Make sure the power indicator shows the power is on.
- ▶ When EBOX unit is plugged into a power strip or UPS (Uninterruptible Power Supply), make sure power strip or UPS is turned on and working normally.
- ▶ Check if the display monitor is properly plugged into a power source and turned on. Make sure the brightness and contrast controls are adjusted correctly. Refer to monitor manual for details.
- ▶ Check if power control button function well by removing the AC adaptor. Wait for one minute, and then reattach all power connection before pressing the power button.
- ▶ Condensation may cause EBOX malfunction for a while. If happens, do not use EBOX for at least one hour.
- ▶ When all above guidelines checked and EBOX unit still not work. Remove the power adaptor from EBOX, unplug the power supply, and plug it in again. Then turn on the power.

B. BIOS Error Message –

BIOS error message appears when EBOX starts

If BIOS error message appears, press any key to resume or, press to enter BIOS setup main menu, follow these steps:

1. Press or <Esc>, and BIOS Setup main menu appears, check if storage is detected. If it is not detected, use Direction keys <↑↓> to choose "AUTO" and then go back to the main menu by pressing <Esc>. Move your cursor down with Direction keys <↓>, and press F10 to "Save and Exit",
2. Go to "Save & Exit", use Direction keys <↑↓> to choose option "Restore Defaults", press <Enter>. A message dialog appears as below, hit "Y" and presses <Enter> to save and recover to the factory setting.

"Restore Defaults (Y/N)? Y"

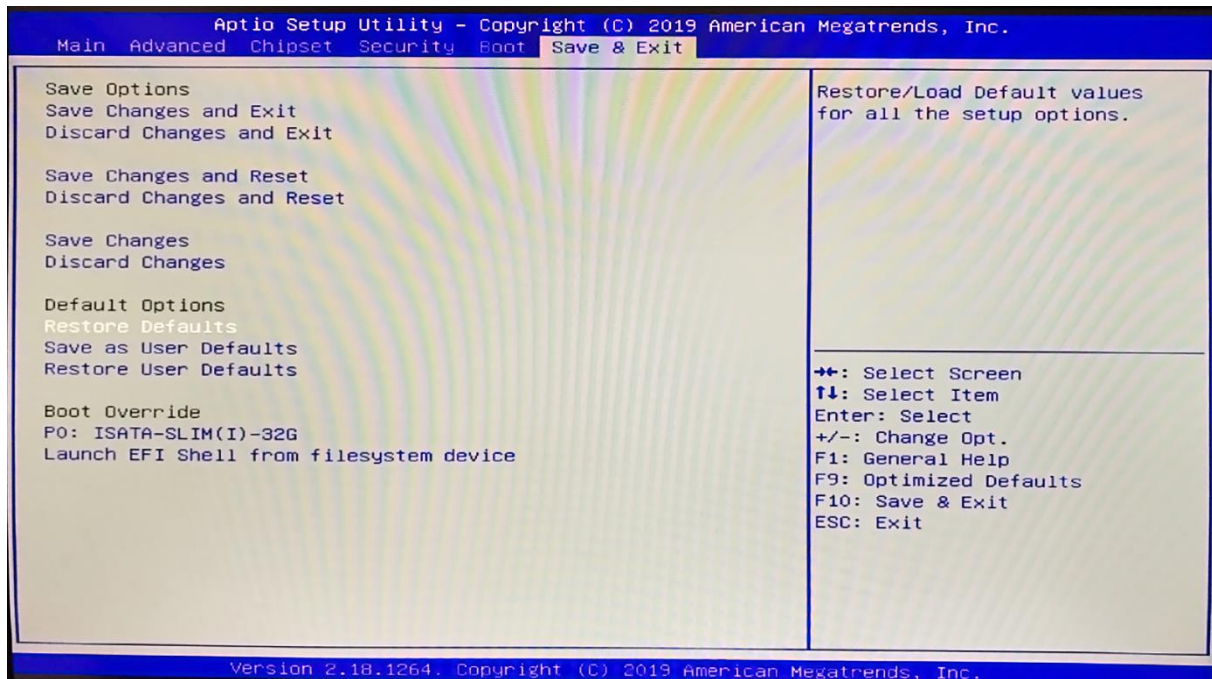

(BIOS Setup menu "Save & Exit")

C. "Operating System Not Found" –

A message indicating "Operating system not found" appears when unit starts

- ▶ Enter BIOS setup main menu by pressing key, be sure that the C: drive is enable.
- ▶ If Windows still does not start, follow these steps to initialize the BIOS:
 1. Turn off EBOX unit.
 2. Remove any peripheral devices connected to EBOX unit.
 3. Restart EBOX unit.
 4. Press or <Esc> to enter BIOS Setup main menu window.
 5. Follow the steps as written in item **B. BIOS error message**.
- ▶ If EBOX unit connected to a CD/ DVD or USB Drivers, remove all peripherals. Restart to check if operating system starts properly. If EBOX unit continues to display "Operating system not found", please contact nearest dealer for servicing.

Chapter 6

Terms and Conditions

Warranty

The warranty terms for EBOX are twelve (12) months from the shipped month of the invoice.

During warranty period, DMP Electronics will repair, replace the product covered under this limited warranty.

Service and Support

DMP Electronics Inc. provides the technical support for hardware problems throughout the warranty period.

The technical support service is limited to configuration and operation of EBOX sold by DMP Electronics Inc.

The technical support service does not offer software tutoring or training.

Return Merchandise Authorization (RMA) policy

If the DMP staff or dealer determines that a part is defective. Purchaser must call for technical support service and obtain an RMA number before attempting to return any part.

To obtain an RMA number, Purchaser must follow procedures as below :

1. Complete the DMP Electronics Inc. standard RMA Form and fax back to the RMA Department.
2. The RMA Number must be used within 7 DAYS.
3. The RMA Number must be shown clearly on your shipping label.
4. DMP Electronics Inc. must receive all Returns before a replacement will be sent.
5. Repair costs depend on the parts, damage reasons, and whether under warranty period...etc.
The Seller will charge the Purchaser with a reasonable price.
6. A copy of the invoice for the RMA product(s) will also be shipped to Purchaser.
7. The freight of return to DMP Electronics Inc. is charged the Purchaser and accompanied by an RMA number.
Any Returns with freight collect will be refused and returned to sender.
After Repairing, the sending back freight costs will be paid by DMP Electronics Inc.
8. DMP Electronics Inc. must receive all returned goods within the warranty period.

Shipping Policy

The Purchaser must pre-pay shipping for any defective system or parts returned within the warranty.

DMP Electronics Inc. shall not be liable for risk of loss or damage during shipment of the returned system or parts.

All products must be shipped back to DMP Electronics Inc. in original or equivalent packaging.

DMP Electronics Inc. will ship the repaired or replacement product(s) to the Purchaser by prepaid freight.

Purchaser assumes the risk of loss. DMP Electronics Inc. shall not be responsible for failure or on-time delivery.